

### GENERAL DESCRIPTION

The SGM41101 is designed for primary protection of Li-Ion/Li-polymer rechargeable cells. The product integrates all the protections required for safe operation of polymer rechargeable cells. The device is packaged in a thin package. Its small solution size leaves more space for fitting the battery cell into a given cavity for small size wearable devices.

The SGM41101 integrates all the protections and the required low on-resistance disconnect switch on one die. The protection features include charging and discharging protection, detection and protection of a cell in over-charging, over-discharging, over-current, and battery under-voltage. The product also disconnects the battery pack in the case of deep discharge.

The SGM41101 operates in -40°C to +85°C temperature range, and is in a thin TDFN-2x2-6L package. This package with a nominal height of 0.75mm is convenient for small cell packing designs.

### FEATURES

- Ultra Compact Protection Solution
- 27mΩ Pass Resistance
- 1μA Operation Current
- Factory Programmable OVP Threshold Options  
4.20V to 4.55V with 0.05V per Step
- Over-Charge/Discharge Current Protection  
3 Thresholds Combination Options
- Battery Under-Voltage Protection  
2.4V/2.5V/2.8V/3.0V Options
- 100nA Deep Discharging Shutdown
- Exhausted Battery Charging from 0.2V
- Input Surge Clamping
- Input Over-Voltage Safe
- Load Short-Circuit Safe
- Reverse Polarity Battery Safe
- Input Reversed-Attaching Safe
- Battery Pack Paralleling Safe
- Locked-Off for Delivery/Assembly
- Available in a Green TDFN-2x2-6L Package

### APPLICATIONS

- IoT Gadgets
- Wearable Devices
- Battery Packs

### TYPICAL APPLICATION

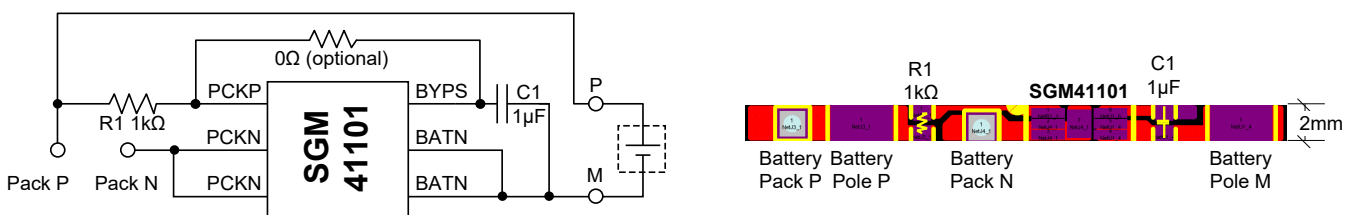


Figure 1. Typical Application Circuit and Demonstration Board Outline

## PACKAGE/ORDERING INFORMATION

MODEL	PACKAGE DESCRIPTION	SPECIFIED TEMPERATURE RANGE	ORDERING NUMBER	PACKAGE MARKING	PACKING OPTION
SGM41101-420M12	TDFN-2×2-6L	-40°C to +85°C	SGM41101-420M12YTDI6G/TR	MX7 XXXX	Tape and Reel, 3000
SGM41101-420M23	TDFN-2×2-6L	-40°C to +85°C	SGM41101-420M23YTDI6G/TR	C40 XXXX	Tape and Reel, 3000
SGM41101-420M46	TDFN-2×2-6L	-40°C to +85°C	SGM41101-420M46YTDI6G/TR	C41 XXXX	Tape and Reel, 3000
SGM41101-420N12	TDFN-2×2-6L	-40°C to +85°C	SGM41101-420N12YTDI6G/TR	C79 XXXX	Tape and Reel, 3000
SGM41101-420N23	TDFN-2×2-6L	-40°C to +85°C	SGM41101-420N23YTDI6G/TR	C42 XXXX	Tape and Reel, 3000
SGM41101-420N46	TDFN-2×2-6L	-40°C to +85°C	SGM41101-420N46YTDI6G/TR	C43 XXXX	Tape and Reel, 3000
SGM41101-420O12	TDFN-2×2-6L	-40°C to +85°C	SGM41101-420O12YTDI6G/TR	C7A XXXX	Tape and Reel, 3000
SGM41101-420O23	TDFN-2×2-6L	-40°C to +85°C	SGM41101-420O23YTDI6G/TR	C44 XXXX	Tape and Reel, 3000
SGM41101-420O46	TDFN-2×2-6L	-40°C to +85°C	SGM41101-420O46YTDI6G/TR	C45 XXXX	Tape and Reel, 3000
SGM41101-420P12	TDFN-2×2-6L	-40°C to +85°C	SGM41101-420P12YTDI6G/TR	C7B XXXX	Tape and Reel, 3000
SGM41101-420P23	TDFN-2×2-6L	-40°C to +85°C	SGM41101-420P23YTDI6G/TR	C46 XXXX	Tape and Reel, 3000
SGM41101-420P46	TDFN-2×2-6L	-40°C to +85°C	SGM41101-420P46YTDI6G/TR	C47 XXXX	Tape and Reel, 3000
SGM41101-425M12	TDFN-2×2-6L	-40°C to +85°C	SGM41101-425M12YTDI6G/TR	C7C XXXX	Tape and Reel, 3000
SGM41101-425M23	TDFN-2×2-6L	-40°C to +85°C	SGM41101-425M23YTDI6G/TR	C48 XXXX	Tape and Reel, 3000
SGM41101-425M46	TDFN-2×2-6L	-40°C to +85°C	SGM41101-425M46YTDI6G/TR	C4A XXXX	Tape and Reel, 3000
SGM41101-425N12	TDFN-2×2-6L	-40°C to +85°C	SGM41101-425N12YTDI6G/TR	C7D XXXX	Tape and Reel, 3000
SGM41101-425N23	TDFN-2×2-6L	-40°C to +85°C	SGM41101-425N23YTDI6G/TR	C4C XXXX	Tape and Reel, 3000
SGM41101-425N46	TDFN-2×2-6L	-40°C to +85°C	SGM41101-425N46YTDI6G/TR	C4D XXXX	Tape and Reel, 3000
SGM41101-425O12	TDFN-2×2-6L	-40°C to +85°C	SGM41101-425O12YTDI6G/TR	C7E XXXX	Tape and Reel, 3000
SGM41101-425O23	TDFN-2×2-6L	-40°C to +85°C	SGM41101-425O23YTDI6G/TR	C4E XXXX	Tape and Reel, 3000
SGM41101-425O46	TDFN-2×2-6L	-40°C to +85°C	SGM41101-425O46YTDI6G/TR	C4F XXXX	Tape and Reel, 3000
SGM41101-425P12	TDFN-2×2-6L	-40°C to +85°C	SGM41101-425P12YTDI6G/TR	C7F XXXX	Tape and Reel, 3000
SGM41101-425P23	TDFN-2×2-6L	-40°C to +85°C	SGM41101-425P23YTDI6G/TR	C50 XXXX	Tape and Reel, 3000
SGM41101-425P46	TDFN-2×2-6L	-40°C to +85°C	SGM41101-425P46YTDI6G/TR	MDA XXXX	Tape and Reel, 3000
SGM41101-430M12	TDFN-2×2-6L	-40°C to +85°C	SGM41101-430M12YTDI6G/TR	C80 XXXX	Tape and Reel, 3000
SGM41101-430M23	TDFN-2×2-6L	-40°C to +85°C	SGM41101-430M23YTDI6G/TR	C51 XXXX	Tape and Reel, 3000

MODEL	PACKAGE DESCRIPTION	SPECIFIED TEMPERATURE RANGE	ORDERING NUMBER	PACKAGE MARKING	PACKING OPTION
SGM41101-430M46	TDFN-2×2-6L	-40°C to +85°C	SGM41101-430M46YTDI6G/TR	C05 XXXX	Tape and Reel, 3000
SGM41101-430N12	TDFN-2×2-6L	-40°C to +85°C	SGM41101-430N12YTDI6G/TR	C81 XXXX	Tape and Reel, 3000
SGM41101-430N23	TDFN-2×2-6L	-40°C to +85°C	SGM41101-430N23YTDI6G/TR	C52 XXXX	Tape and Reel, 3000
SGM41101-430N46	TDFN-2×2-6L	-40°C to +85°C	SGM41101-430N46YTDI6G/TR	C53 XXXX	Tape and Reel, 3000
SGM41101-430O12	TDFN-2×2-6L	-40°C to +85°C	SGM41101-430O12YTDI6G/TR	C82 XXXX	Tape and Reel, 3000
SGM41101-430O23	TDFN-2×2-6L	-40°C to +85°C	SGM41101-430O23YTDI6G/TR	C54 XXXX	Tape and Reel, 3000
SGM41101-430O46	TDFN-2×2-6L	-40°C to +85°C	SGM41101-430O46YTDI6G/TR	C55 XXXX	Tape and Reel, 3000
SGM41101-430P12	TDFN-2×2-6L	-40°C to +85°C	SGM41101-430P12YTDI6G/TR	C83 XXXX	Tape and Reel, 3000
SGM41101-430P23	TDFN-2×2-6L	-40°C to +85°C	SGM41101-430P23YTDI6G/TR	C56 XXXX	Tape and Reel, 3000
SGM41101-430P46	TDFN-2×2-6L	-40°C to +85°C	SGM41101-430P46YTDI6G/TR	MDB XXXX	Tape and Reel, 3000
SGM41101-435M12	TDFN-2×2-6L	-40°C to +85°C	SGM41101-435M12YTDI6G/TR	C84 XXXX	Tape and Reel, 3000
SGM41101-435M23	TDFN-2×2-6L	-40°C to +85°C	SGM41101-435M23YTDI6G/TR	C57 XXXX	Tape and Reel, 3000
SGM41101-435M46	TDFN-2×2-6L	-40°C to +85°C	SGM41101-435M46YTDI6G/TR	C58 XXXX	Tape and Reel, 3000
SGM41101-435N12	TDFN-2×2-6L	-40°C to +85°C	SGM41101-435N12YTDI6G/TR	C85 XXXX	Tape and Reel, 3000
SGM41101-435N23	TDFN-2×2-6L	-40°C to +85°C	SGM41101-435N23YTDI6G/TR	C59 XXXX	Tape and Reel, 3000
SGM41101-435N46	TDFN-2×2-6L	-40°C to +85°C	SGM41101-435N46YTDI6G/TR	C5A XXXX	Tape and Reel, 3000
SGM41101-435O12	TDFN-2×2-6L	-40°C to +85°C	SGM41101-435O12YTDI6G/TR	C86 XXXX	Tape and Reel, 3000
SGM41101-435O23	TDFN-2×2-6L	-40°C to +85°C	SGM41101-435O23YTDI6G/TR	C5B XXXX	Tape and Reel, 3000
SGM41101-435O46	TDFN-2×2-6L	-40°C to +85°C	SGM41101-435O46YTDI6G/TR	C5C XXXX	Tape and Reel, 3000
SGM41101-435P12	TDFN-2×2-6L	-40°C to +85°C	SGM41101-435P12YTDI6G/TR	C87 XXXX	Tape and Reel, 3000
SGM41101-435P23	TDFN-2×2-6L	-40°C to +85°C	SGM41101-435P23YTDI6G/TR	C5D XXXX	Tape and Reel, 3000
SGM41101-435P46	TDFN-2×2-6L	-40°C to +85°C	SGM41101-435P46YTDI6G/TR	M96 XXXX	Tape and Reel, 3000
SGM41101-440M12	TDFN-2×2-6L	-40°C to +85°C	SGM41101-440M12YTDI6G/TR	C88 XXXX	Tape and Reel, 3000
SGM41101-440M23	TDFN-2×2-6L	-40°C to +85°C	SGM41101-440M23YTDI6G/TR	C5E XXXX	Tape and Reel, 3000
SGM41101-440M46	TDFN-2×2-6L	-40°C to +85°C	SGM41101-440M46YTDI6G/TR	C5F XXXX	Tape and Reel, 3000
SGM41101-440N12	TDFN-2×2-6L	-40°C to +85°C	SGM41101-440N12YTDI6G/TR	C89 XXXX	Tape and Reel, 3000
SGM41101-440N23	TDFN-2×2-6L	-40°C to +85°C	SGM41101-440N23YTDI6G/TR	MZ0 XXXX	Tape and Reel, 3000

# SGM41101

# True Monolithic Li-Ion/Li-Polymer Battery Protector in Thin Package

MODEL	PACKAGE DESCRIPTION	SPECIFIED TEMPERATURE RANGE	ORDERING NUMBER	PACKAGE MARKING	PACKING OPTION
SGM41101-440N46	TDFN-2x2-6L	-40°C to +85°C	SGM41101-440N46YTDI6G/TR	C60 XXXX	Tape and Reel, 3000
SGM41101-440O12	TDFN-2x2-6L	-40°C to +85°C	SGM41101-440O12YTDI6G/TR	C8A XXXX	Tape and Reel, 3000
SGM41101-440O23	TDFN-2x2-6L	-40°C to +85°C	SGM41101-440O23YTDI6G/TR	C61 XXXX	Tape and Reel, 3000
SGM41101-440O46	TDFN-2x2-6L	-40°C to +85°C	SGM41101-440O46YTDI6G/TR	C06 XXXX	Tape and Reel, 3000
SGM41101-440P12	TDFN-2x2-6L	-40°C to +85°C	SGM41101-440P12YTDI6G/TR	C8B XXXX	Tape and Reel, 3000
SGM41101-440P23	TDFN-2x2-6L	-40°C to +85°C	SGM41101-440P23YTDI6G/TR	C62 XXXX	Tape and Reel, 3000
SGM41101-440P46	TDFN-2x2-6L	-40°C to +85°C	SGM41101-440P46YTDI6G/TR	C63 XXXX	Tape and Reel, 3000
SGM41101-445M12	TDFN-2x2-6L	-40°C to +85°C	SGM41101-445M12YTDI6G/TR	C8C XXXX	Tape and Reel, 3000
SGM41101-445M23	TDFN-2x2-6L	-40°C to +85°C	SGM41101-445M23YTDI6G/TR	C64 XXXX	Tape and Reel, 3000
SGM41101-445M46	TDFN-2x2-6L	-40°C to +85°C	SGM41101-445M46YTDI6G/TR	C65 XXXX	Tape and Reel, 3000
SGM41101-445N12	TDFN-2x2-6L	-40°C to +85°C	SGM41101-445N12YTDI6G/TR	C8D XXXX	Tape and Reel, 3000
SGM41101-445N23	TDFN-2x2-6L	-40°C to +85°C	SGM41101-445N23YTDI6G/TR	C66 XXXX	Tape and Reel, 3000
SGM41101-445N46	TDFN-2x2-6L	-40°C to +85°C	SGM41101-445N46YTDI6G/TR	C67 XXXX	Tape and Reel, 3000
SGM41101-445O12	TDFN-2x2-6L	-40°C to +85°C	SGM41101-445O12YTDI6G/TR	C8E XXXX	Tape and Reel, 3000
SGM41101-445O23	TDFN-2x2-6L	-40°C to +85°C	SGM41101-445O23YTDI6G/TR	C68 XXXX	Tape and Reel, 3000
SGM41101-445O46	TDFN-2x2-6L	-40°C to +85°C	SGM41101-445O46YTDI6G/TR	C69 XXXX	Tape and Reel, 3000
SGM41101-445P12	TDFN-2x2-6L	-40°C to +85°C	SGM41101-445P12YTDI6G/TR	C8F XXXX	Tape and Reel, 3000
SGM41101-445P23	TDFN-2x2-6L	-40°C to +85°C	SGM41101-445P23YTDI6G/TR	C6A XXXX	Tape and Reel, 3000
SGM41101-445P46	TDFN-2x2-6L	-40°C to +85°C	SGM41101-445P46YTDI6G/TR	MDC XXXX	Tape and Reel, 3000
SGM41101-450M12	TDFN-2x2-6L	-40°C to +85°C	SGM41101-450M12YTDI6G/TR	C90 XXXX	Tape and Reel, 3000
SGM41101-450M23	TDFN-2x2-6L	-40°C to +85°C	SGM41101-450M23YTDI6G/TR	C6B XXXX	Tape and Reel, 3000
SGM41101-450M46	TDFN-2x2-6L	-40°C to +85°C	SGM41101-450M46YTDI6G/TR	C6C XXXX	Tape and Reel, 3000
SGM41101-450N12	TDFN-2x2-6L	-40°C to +85°C	SGM41101-450N12YTDI6G/TR	C91 XXXX	Tape and Reel, 3000
SGM41101-450N23	TDFN-2x2-6L	-40°C to +85°C	SGM41101-450N23YTDI6G/TR	C6D XXXX	Tape and Reel, 3000
SGM41101-450N46	TDFN-2x2-6L	-40°C to +85°C	SGM41101-450N46YTDI6G/TR	C6E XXXX	Tape and Reel, 3000
SGM41101-450O12	TDFN-2x2-6L	-40°C to +85°C	SGM41101-450O12YTDI6G/TR	C92 XXXX	Tape and Reel, 3000
SGM41101-450O23	TDFN-2x2-6L	-40°C to +85°C	SGM41101-450O23YTDI6G/TR	C6F XXXX	Tape and Reel, 3000

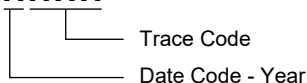
MODEL	PACKAGE DESCRIPTION	SPECIFIED TEMPERATURE RANGE	ORDERING NUMBER	PACKAGE MARKING	PACKING OPTION
SGM41101-450O46	TDFN-2x2-6L	-40°C to +85°C	SGM41101-450O46YTDI6G/TR	C70 XXXX	Tape and Reel, 3000
SGM41101-450P12	TDFN-2x2-6L	-40°C to +85°C	SGM41101-450P12YTDI6G/TR	C93 XXXX	Tape and Reel, 3000
SGM41101-450P23	TDFN-2x2-6L	-40°C to +85°C	SGM41101-450P23YTDI6G/TR	C71 XXXX	Tape and Reel, 3000
SGM41101-450P46	TDFN-2x2-6L	-40°C to +85°C	SGM41101-450P46YTDI6G/TR	C72 XXXX	Tape and Reel, 3000
SGM41101-455M12	TDFN-2x2-6L	-40°C to +85°C	SGM41101-455M12YTDI6G/TR	C94 XXXX	Tape and Reel, 3000
SGM41101-455M23	TDFN-2x2-6L	-40°C to +85°C	SGM41101-455M23YTDI6G/TR	C73 XXXX	Tape and Reel, 3000
SGM41101-455M46	TDFN-2x2-6L	-40°C to +85°C	SGM41101-455M46YTDI6G/TR	C74 XXXX	Tape and Reel, 3000
SGM41101-455N12	TDFN-2x2-6L	-40°C to +85°C	SGM41101-455N12YTDI6G/TR	C95 XXXX	Tape and Reel, 3000
SGM41101-455N23	TDFN-2x2-6L	-40°C to +85°C	SGM41101-455N23YTDI6G/TR	C75 XXXX	Tape and Reel, 3000
SGM41101-455N46	TDFN-2x2-6L	-40°C to +85°C	SGM41101-455N46YTDI6G/TR	C76 XXXX	Tape and Reel, 3000
SGM41101-455O12	TDFN-2x2-6L	-40°C to +85°C	SGM41101-455O12YTDI6G/TR	C96 XXXX	Tape and Reel, 3000
SGM41101-455O23	TDFN-2x2-6L	-40°C to +85°C	SGM41101-455O23YTDI6G/TR	MX8 XXXX	Tape and Reel, 3000
SGM41101-455O46	TDFN-2x2-6L	-40°C to +85°C	SGM41101-455O46YTDI6G/TR	C77 XXXX	Tape and Reel, 3000
SGM41101-455P12	TDFN-2x2-6L	-40°C to +85°C	SGM41101-455P12YTDI6G/TR	C97 XXXX	Tape and Reel, 3000
SGM41101-455P23	TDFN-2x2-6L	-40°C to +85°C	SGM41101-455P23YTDI6G/TR	C78 XXXX	Tape and Reel, 3000
SGM41101-455P46	TDFN-2x2-6L	-40°C to +85°C	SGM41101-455P46YTDI6G/TR	C02 XXXX	Tape and Reel, 3000

## MARKING INFORMATION

NOTE: XXXX = Date Code and Trace Code.

**YYY** — Serial Number

**XXXX**



Green (RoHS & HSF): SG Micro Corp defines "Green" to mean Pb-Free (RoHS compatible) and free of halogen substances. If you have additional comments or questions, please contact your SGMICRO representative directly.

## DEVICE DESCRIPTION

Model: SGM41101-AAABCC

Over-Voltage Threshold Options								
Option Code "AAA"	420	425	430	435	440	445	450	455
Over-Voltage Threshold $V_{OV}$ (V)	4.20	4.25	4.30	4.35	4.40	4.45	4.50	4.55
Under-Voltage Threshold Options								
Option Code "B"	M		N		O		P	
Under-Voltage Threshold $V_{UV}$ (V)	2.4		2.5		2.8		3.0	
Current Threshold Combination Options								
Option Code "CC"	12		23		46			
Over-Charge Current $I_{OC}$ (A)	0.9		1.8		3.6			
Over-Discharge Current $I_{OD}$ (A)	1.2		2.3		4.6			
Short-Circuit Current (A)	2 × 1.2		2 × 2.3		2 × 4.6			

**ABSOLUTE MAXIMUM RATINGS**

PCKP to PCKN, 13V <sup>(1)</sup> , 10mA Clamping <sup>(2)</sup> .....	5s
PCKP to PCKN.....	-4.5V or +9V <sup>(3)</sup> , Continuous
PCKP to BATN.....	-4.5V <sup>(3)</sup> or +5.5V
PCKP to PCKN Short Circuit <sup>(4)</sup> .....	Continuous
PCKP to PCKN Attachment Inrush/Outrush <sup>(5)</sup> .....	+9V/-4.5V
PCKP to BATN Attachment Inrush/Outrush <sup>(6)</sup> .....	±4.5V
Surge Current <sup>(7)</sup> .....	±20A
Junction Temperature.....	+150°C
Storage Temperature Range.....	-65°C to +150°C
Lead Temperature (Soldering, 10 sec).....	+260°C
ESD Susceptibility	
HBM.....	4000V
MM.....	300V
CDM.....	1000V

**NOTES:**

1. Evaluation at V<sub>BAT</sub> = 4.5V.
2. The clamping may reach 10mA at an input voltage > 13V.
3. Test with a voltage regulated supply that has 2A current limit and increase the voltage progressively for less than 1V/ms slope rate. Apply a voltage to the device under test from 0V to given voltages.
4. The device is tested after being installed on the circuit board in Figure 1. Clip a 4.5V 5A power source onto the P and M to simulate a battery and short the Pack P and the Pack N with an 80mΩ wire.
5. The device is tested after being installed on the circuit board in Figure 1. Connect a 3.2V supply and 2A sinking resistor R<sub>SINK</sub> as showed in Figure 2 to the P and M for inrush test. Clip a 4.5V 5A supply for outrush test.
6. The device is tested after being installed on the circuit board in Figure 1 with the circuit in Figure 3.
7. Parallel or connect in reverse polarity two battery packs of Figure 1. Limit the battery pack impedance to limit the surge current to 20A.

**RECOMMENDED OPERATING CONDITIONS**

Supply Voltage Range.....	0V to 6V
Battery Voltage Range.....	0 to 4.5V
Operating Temperature Range.....	-40°C to +85°C

**OVERSTRESS CAUTION**

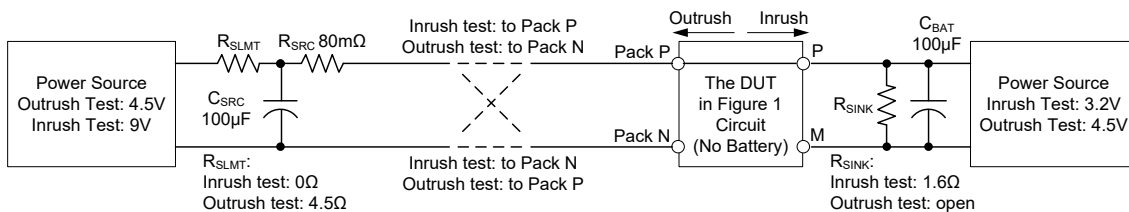
Stresses beyond those listed in Absolute Maximum Ratings may cause permanent damage to the device. Exposure to absolute maximum rating conditions for extended periods may affect reliability. Functional operation of the device at any conditions beyond those indicated in the Recommended Operating Conditions section is not implied.

**ESD SENSITIVITY CAUTION**

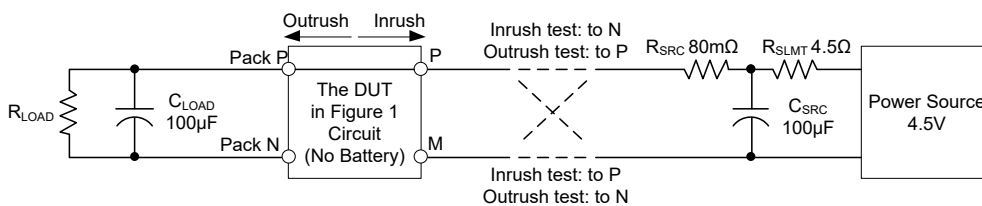
This integrated circuit can be damaged by ESD if you don't pay attention to ESD protection. SGMICRO recommends that all integrated circuits be handled with appropriate precautions. Failure to observe proper handling and installation procedures can cause damage. ESD damage can range from subtle performance degradation to complete device failure. Precision integrated circuits may be more susceptible to damage because very small parametric changes could cause the device not to meet its published specifications.

**DISCLAIMER**

SG Micro Corp reserves the right to make any change in circuit design, or specifications without prior notice.

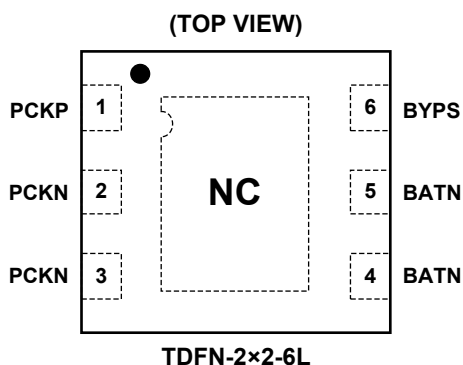


**Figure 2. Test Set-Up for Pack P to Pack N Attachment Inrush/Outrush**



**Figure 3. Test Set-Up for Pack P to BATN Attachment Inrush/Outrush**

## PIN CONFIGURATION



## PIN DESCRIPTION

PIN	NAME	TYPE	FUNCTION
1	PCKP	P	Power Input and Output, the Battery Pack Positive Connection. The default state after battery attached is closed or locked-off, dependent on the external circuitry. Connect a 200nF capacitor between PCKN and BATN for setting the default state to closed. It is recommended to connect a 0Ω resistor between PCKP and BYPS for suppressing noise applied to the PCKP input.
2, 3	PCKN	P	Power Input and Output, the Battery Pack Cathode. Short this pin to the BATN pin to release off the locked-open state, and make the output path closed.
4, 5	BATN	G	Ground of Internal Circuit. Connect to the battery cathode end.
6	BYPS	I/O	Bypass Pin and Disconnection Locked-Off Triggering Input. Place a 1μF capacitor between this pin and BATN pin. Shorting this pin to PCKN pin momentarily places the circuit into locked-open state.
Exposed Pad	NC	NC	Not Connected Internally. Can be connected to BATN or PCKN if needed.

NOTE: I/O: input or output; G: ground; P: power for the circuit; NC: not connected.



## ELECTRICAL CHARACTERISTICS

(T<sub>J</sub> = +25°C, I<sub>CHG</sub> = I<sub>DIS</sub> = 200mA, V<sub>BAT</sub> = 3.7V, unless otherwise noted.)

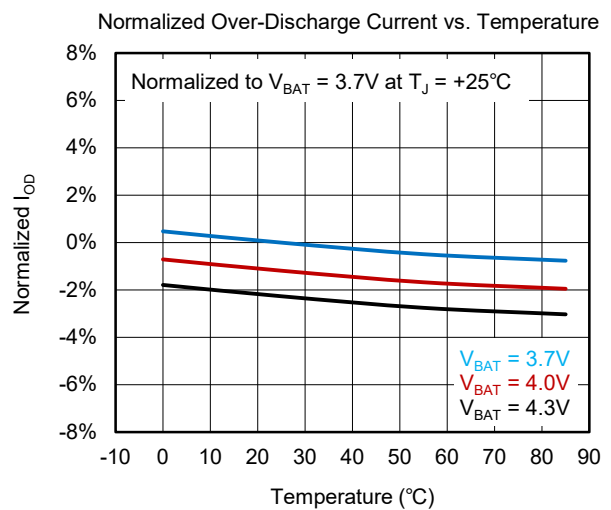
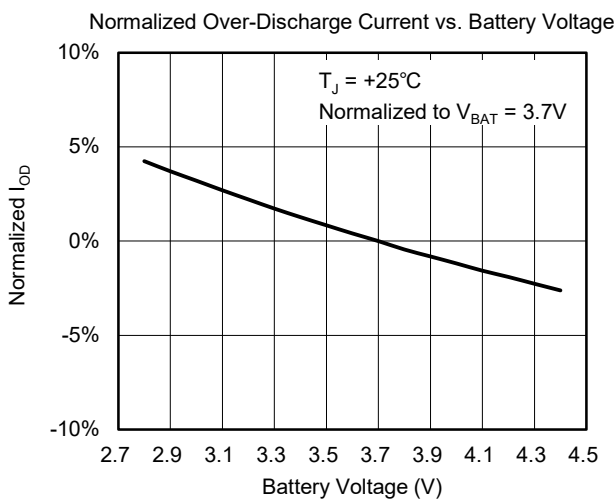
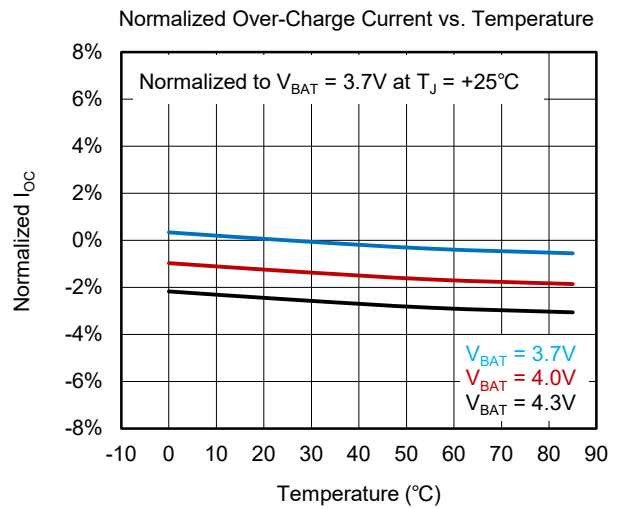
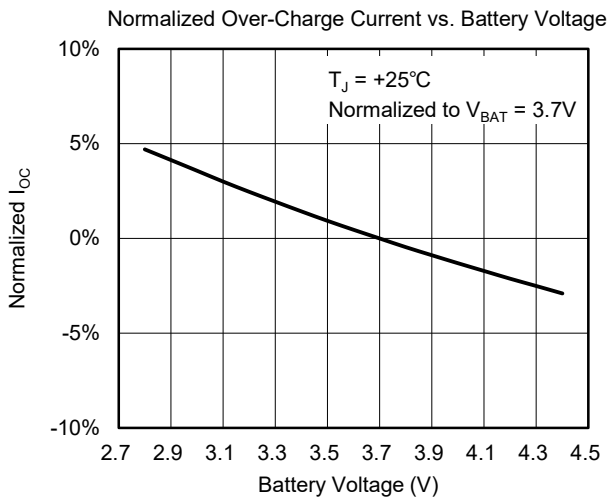
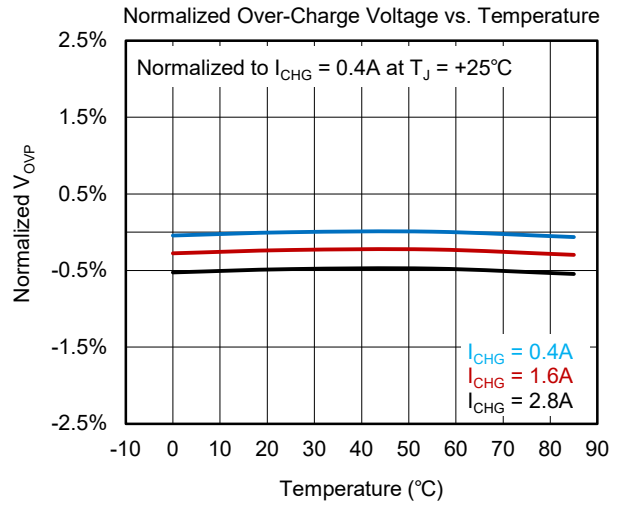
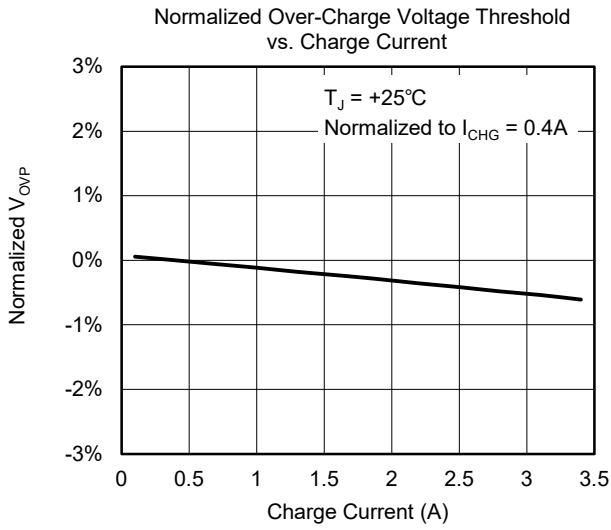
PARAMETER	SYMBOL	CONDITIONS	MIN	TYP	MAX	UNITS				
Over-Charge Voltage Threshold	V <sub>OV</sub>	SGM41101-420_ _ _	T <sub>J</sub> = +25°C	4.180	4.200	4.220	V			
			T <sub>J</sub> = -20°C to +55°C	4.165		4.235				
			T <sub>J</sub> = -40°C to +85°C	4.145		4.255				
		SGM41101-425_ _ _	T <sub>J</sub> = +25°C	4.230	4.250	4.270				
			T <sub>J</sub> = -20°C to +55°C	4.215		4.285				
			T <sub>J</sub> = -40°C to +85°C	4.195		4.305				
		SGM41101-430_ _ _	T <sub>J</sub> = +25°C	4.280	4.300	4.320				
			T <sub>J</sub> = -20°C to +55°C	4.265		4.335				
			T <sub>J</sub> = -40°C to +85°C	4.245		4.355				
		SGM41101-435_ _ _	T <sub>J</sub> = +25°C	4.330	4.350	4.370				
			T <sub>J</sub> = -20°C to +55°C	4.315		4.385				
			T <sub>J</sub> = -40°C to +85°C	4.295		4.405				
		SGM41101-440_ _ _	T <sub>J</sub> = +25°C	4.380	4.400	4.420				
			T <sub>J</sub> = -20°C to +55°C	4.365		4.435				
			T <sub>J</sub> = -40°C to +85°C	4.345		4.455				
		SGM41101-445_ _ _	T <sub>J</sub> = +25°C	4.430	4.450	4.470				
			T <sub>J</sub> = -20°C to +55°C	4.415		4.485				
			T <sub>J</sub> = -40°C to +85°C	4.395		4.505				
		SGM41101-450_ _ _	T <sub>J</sub> = +25°C	4.480	4.500	4.520				
			T <sub>J</sub> = -20°C to +55°C	4.465		4.535				
			T <sub>J</sub> = -40°C to +85°C	4.445		4.555				
		SGM41101-455_ _ _	T <sub>J</sub> = +25°C	4.530	4.550	4.570				
			T <sub>J</sub> = -20°C to +55°C	4.515		4.585				
			T <sub>J</sub> = -40°C to +85°C	4.495		4.605				
		OV Release Hysteresis	V <sub>OVHYS</sub>	Charger voltage lower than battery voltage.	T <sub>J</sub> = -40°C to +85°C	75		100	125	mV
		Battery Under Voltage Threshold	V <sub>UV</sub>	SGM41101- _ _ _ M _ _	T <sub>J</sub> = +25°C	2.36		2.40	2.44	V
					T <sub>J</sub> = -20°C to +55°C	2.34			2.46	
					T <sub>J</sub> = -40°C to +85°C	2.32			2.48	
				SGM41101- _ _ _ N _ _	T <sub>J</sub> = +25°C	2.46		2.50	2.54	
					T <sub>J</sub> = -20°C to +55°C	2.44			2.56	
					T <sub>J</sub> = -40°C to +85°C	2.42			2.58	
				SGM41101- _ _ _ O _ _	T <sub>J</sub> = +25°C	2.76		2.80	2.84	
					T <sub>J</sub> = -20°C to +55°C	2.74			2.86	
					T <sub>J</sub> = -40°C to +85°C	2.72			2.88	
				SGM41101- _ _ _ P _ _	T <sub>J</sub> = +25°C	2.96		3.00	3.04	
					T <sub>J</sub> = -20°C to +55°C	2.94			3.06	
T <sub>J</sub> = -40°C to +85°C	2.92				3.08					
UV Release Hysteresis	V <sub>UVHYS</sub>	When a charging supply is applied.	T <sub>J</sub> = -40°C to +85°C	80	100	120	mV			
Shutdown Voltage	V <sub>SHDN</sub>	T <sub>J</sub> = +25°C	1.40	1.67	1.90	V				
		T <sub>J</sub> = -40°C to +85°C	1.20		2.10					

**ELECTRICAL CHARACTERISTICS (continued)**(T<sub>J</sub> = +25°C, I<sub>CHG</sub> = I<sub>DIS</sub> = 200mA, V<sub>BAT</sub> = 3.7V, unless otherwise noted.)

PARAMETER	SYMBOL	CONDITIONS	MIN	TYP	MAX	UNITS
Over-Discharge Current	I <sub>OD</sub>	SGM41101-____12	T <sub>J</sub> = +25°C	1.00	1.20	1.40
			T <sub>J</sub> = -40°C to +85°C	0.80		1.60
		SGM41101-____23	T <sub>J</sub> = +25°C	1.95	2.30	2.65
			T <sub>J</sub> = -40°C to +85°C	1.20		3.00
		SGM41101-____46	T <sub>J</sub> = +25°C	4.00	4.60	5.20
			T <sub>J</sub> = -40°C to +85°C	3.30		5.90
Over-Charge Current	I <sub>OC</sub>	SGM41101-____12	T <sub>J</sub> = +25°C	0.70	0.90	1.10
			T <sub>J</sub> = -40°C to +85°C	0.50		1.30
		SGM41101-____23	T <sub>J</sub> = +25°C	1.50	1.80	2.10
			T <sub>J</sub> = -40°C to +85°C	1.20		2.40
		SGM41101-____46	T <sub>J</sub> = +25°C	3.10	3.60	4.10
			T <sub>J</sub> = -40°C to +85°C	2.50		4.70
Pass Resistance	R <sub>P</sub>	T <sub>J</sub> = +25°C		27	32	mΩ
		T <sub>J</sub> = -40°C to +85°C			40	
Operating Current	I <sub>OP</sub>	T <sub>J</sub> = +25°C		1.0	1.3	μA
		T <sub>J</sub> = -40°C to +85°C			1.5	
Shutdown Current	I <sub>SHDN</sub>	The stable current when the device is in any shutdown condition including that of voltage lower than V <sub>SHDN</sub> , of lower than V <sub>UV</sub> and of latch-off.			0.1	μA
Over-Voltage Detection Delay	t <sub>OVPD</sub>		0.75	1.12	1.48	s
Under-Voltage Detection Delay	t <sub>UVPD</sub>		0.09	0.13	0.18	s
Over-Discharge Current Detection Delay	t <sub>ODD</sub>		47	69	92	ms
Over-Discharge Current Retry Time	t <sub>RETRY</sub>		0.18	0.28	0.37	s
Over-Discharge Current Retries	N			8		Times
Over-Charge Current Detection Delay	t <sub>OCD</sub>		47	69	92	ms
Discharge Short-Circuit Detection Delay	t <sub>OCSD</sub>		0.09	0.30		ms
Discharge Short-Circuit Current	I <sub>SC</sub>			2×I <sub>OD</sub>		A

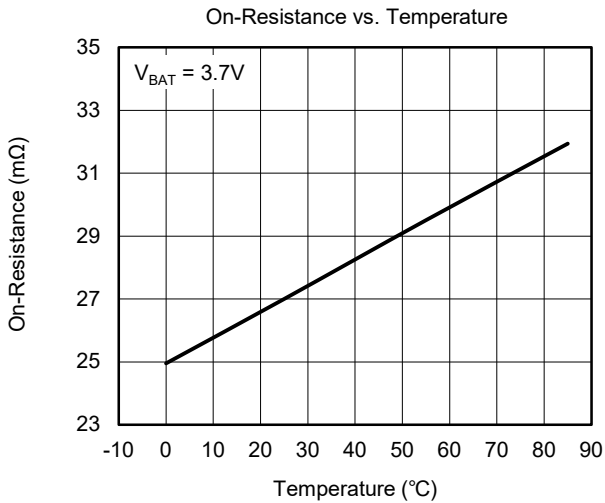
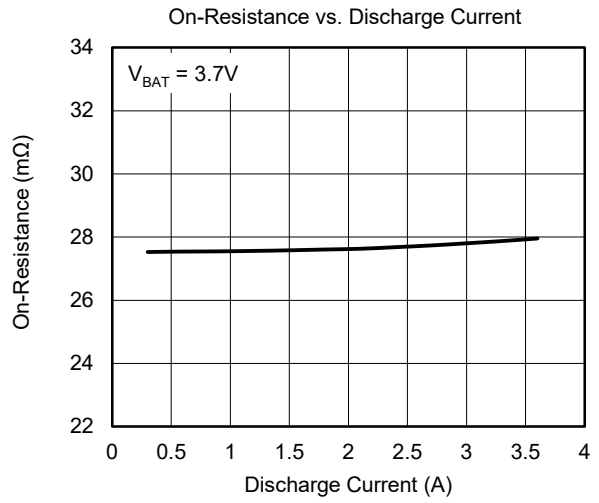
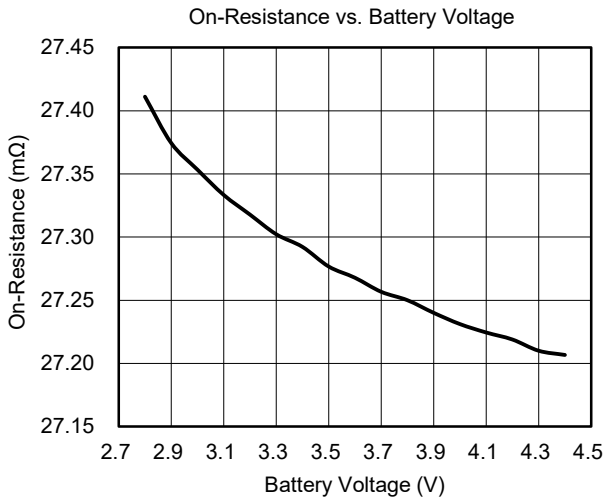
TYPICAL PERFORMANCE CHARACTERISTICS

$T_J = +25^\circ\text{C}$ ,  $I_{\text{CHG}} = I_{\text{DIS}} = 200\text{mA}$ ,  $V_{\text{BAT}} = 3.7\text{V}$ , unless otherwise noted.



**TYPICAL PERFORMANCE CHARACTERISTICS (continued)**

$T_J = +25^\circ\text{C}$ ,  $I_{\text{CHG}} = I_{\text{DIS}} = 200\text{mA}$ ,  $V_{\text{BAT}} = 3.7\text{V}$ , unless otherwise noted.



## FUNCTION DESCRIPTION

The SGM41101 monitors voltage and current applied on battery cell connected between PCKP and BATN, and opens the connection between battery and pack terminal with its internal switches when a fault condition is detected.

### Voltage Related Protections

When battery voltage reaches over-voltage threshold ( $V_{OV}$ ), the charging path is open circuited. The path closes again when the charger voltage is lower than battery voltage and the battery voltage falls back about  $V_{OVHYS}$  below the over-voltage threshold ( $V_{OV}$ ).

In order to protect the battery from over discharging when battery voltage falls below  $V_{UV}$ , the discharge path is open circuited. If the battery voltage falls low further, at about 1.67V, the SGM41101 enters into shutdown in order to further reduce the current consumption, which helps to keep the battery from harmful exhausted conditions as long as possible. The path closes again when a charging supply is applied and the battery voltage rises to about  $V_{UVHYS}$  above the  $V_{UV}$  threshold.

**Charge an exhausted battery:** While the battery is over-discharged the battery could be in the following states.

- a) Battery below 0.2V: When the battery voltage (PCKP to BATN) is lower than 0.2V, all charge and discharge paths are disconnected.
- b) Battery voltage between 0.2V to shutdown threshold: In this state the battery charges through the internal power MOSFET body diode. All internal circuitry is OFF. Discharge is not allowed.
- c) Battery voltage between shutdown threshold and under-voltage threshold: In this condition the part allows charging in hiccup mode and over-charge current detection and protection are provided. During hiccup mode the power MOSFET is ON for 128ms, and OFF for 2ms. During the 2ms OFF time of the power MOSFET, the battery is charged through the power MOSFET body diode. Discharging of the battery is not allowed.
- d) Battery voltage above under-voltage threshold: In this condition the chip enters normal operation and charge and discharge modes are allowed.

### Current Related Protections

When over-discharging current condition occurs and keeps for over-discharge current detection delay ( $t_{ODD}$ ), the discharging path opens. The path closes again after  $t_{RETRY}$  for retrying. The SGM41101 keeps retrying for N (8) times. If the over-current condition remains after N retries, the SGM41101 enters a non-conducting locked-off state and stays in this state until being reactivated.

During a charging condition if an over-charging current is identified, the SGM41101 enters the locked-off state. This state can be reset by charger removal (pack removal).

**Short-circuit protection:** When discharge current exceeds 2 times of the over-current threshold, discharging path disconnects instantly in  $t_{OCSD}$ , in order to protect the battery from potential over-current stress. After this disconnection, the SGM41101 stays in the locked-off non-conducting state until being reactivated.

**Burst load outrush:** In many systems momentarily over load conditions occur. The device allows for this short duration discharge conditions by allowing the discharge path to remain closed even after an over-discharge current is detected for a duration of over-discharge current detection delay.

When an over-charging current condition is identified, and after over-charge current detection delay the charging path is cut off. The device restores to the conducting state when the PCKP to PCKN voltage drops about 30mV lower than the battery voltage.

**Parallel battery packs:** When paralleling two battery packs utilizing SGM41101s, a momentary current surge may occur and cause over-charge current protection in the pack with the lower voltage. The higher voltage pack could enter an over-discharge current protection. The over-charge current or over-discharge current protection resets only after the higher voltage battery pack discharges to a voltage slightly lower than the lower voltage pack. After this discharge both packs will conduct.

It is highly recommended that the packs be placed into a locked-open non-conducting state first (by connecting BYPS to PCKN momentarily) before being paralleled to avoid current over-stress. When a charging supply is applied to the paralleled packs the locked-open state will release.

## FUNCTION DESCRIPTION (continued)

**Battery delivery state:** It is recommended to deliver a battery pack in a locked-off non-conducting state to avoid unintentional shorting in production handling or transportation. The circuit of Figure 1 places the SGM41101 into a locked-off state after battery attachment by momentarily shorting BYPS and PCKN.

Connecting a 220nF capacitor clapping between the BATN and PCKN may place the device into conducting state, which might couple enough charge for making enough voltage difference between the PCKN and PCKP for over about 1.3V. The voltage difference is the dividing result of the clapping capacitance and the load resistance and capacitance. The 220nF capacitance is recommended for no load condition.

**Pack activation:** In order to release the pack from locked-off state and to place it into a conducting state, apply a charging input, or connect the PCKN and BATN momentarily when there is no high load capacitance.

**Caution:** Charging the load capacitance may induce excessive high current surge when shorting the PCKN and BATN with a bit of low resistance jumping wire or metal tweezers, which may cause damage to the device if contact bouncing occurs during the current surge. Do not short the PCKN and BATN for activation unless it is certain no capacitor is loaded.

### Surge, ESD and Reversed Attachment

The SGM41101 absorbs voltage surge applied between PCKP and PCKN, by passing the surge current through its switch and the battery. Surge may occur when attaching the pack or battery cell.

The SGM41101 survives either if a cell is placed in reverse or a charge input is attached in reverse, but not both at the same time. Any of these reversed attachments, short circuit, inrush surge and outrush, causes over-stress. Do not test those cases in normal production inspection, as this kind of test itself may cause performance degradation or even damage the device.

**Caution about ESD damage to the battery:** The battery pack might be the biggest piece of elements in equipment and induce much during an ESD event. Careful design of guided discharge path is desired for

the equipment case sealing air-gap discharge over the battery and those connect to the battery closely.

**Caution on electrochemical corrosion:** As a battery can apply potential over the electrodes continuously and cause electrochemical corrosion, the corrosion product may spread in the hollow beneath a surface mount device and cause leakage. Moisture-proof coating is recommended especially when using compact devices.

### Cautions for Evaluation Test

Some types of electronic load simulator may have excessive inrush current, and some BPM testers may have voltage transition surge, which may trigger the protection of the SGM41101. Careful attention is required for doing such evaluations with these kinds of equipment. External voltage and current limits within the conditions specified in the Absolute Maximum Ratings section of this datasheet are required.

### Select Protection Parameters

Battery models from different vendors may be customized for different applications. Consult the battery vendor for protection limits for specific battery model.

Parameters for the protection circuit and of the charger circuit affecting same variables should be set for proper charge or discharge protection sequence. For example, the over-voltage threshold of the battery should be 50mV ~ 100mV higher than constant voltage threshold of the charger.

**Cautions on parameter misalignment:** If the  $V_{OV}$  is lower than the battery charger's full of charge voltage, the protection circuit cuts off the battery charge path before the battery is fully charged, and turns into the non-conductive locked-off state; if the  $I_{OC}$  is lower than the charger's charge current, the protection circuit also turns itself into the locked-off state. In either  $V_{OV}$  or  $I_{OC}$ , the charger input should be removed and then re-applied for activating the protection circuit from the locked-off state to the conducting state. If the charger is not removed after a  $V_{OV}$  or  $I_{OV}$  event, the battery will not be charged even if the battery voltage depletes.

**REVISION HISTORY**

NOTE: Page numbers for previous revisions may differ from page numbers in the current version.

<b>SEPTEMBER 2019 – REV.A.1 to REV.A.2</b>	<b>Page</b>
Updated Function Description section.....	14, 15

---

<b>APRIL 2019 – REV.A to REV.A.1</b>	<b>Page</b>
Updated Typical Application section .....	1
Updated Pin Description section.....	8

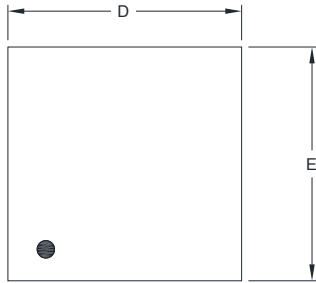
---

<b>Changes from Original (DECEMBER 2018) to REV.A</b>	<b>Page</b>
Changed from product preview to production data.....	All

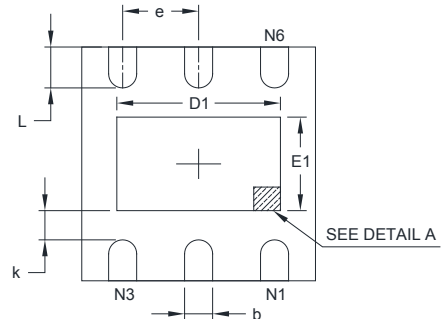
---

PACKAGE OUTLINE DIMENSIONS

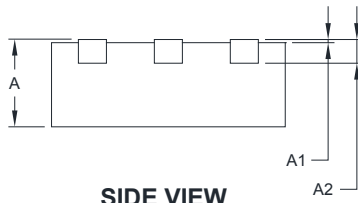
TDFN-2x2-6L



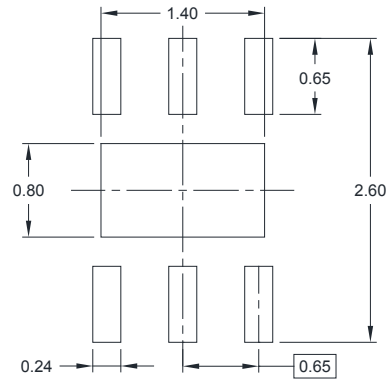
TOP VIEW



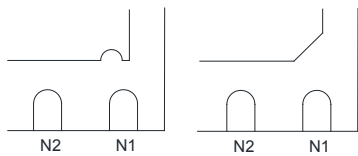
BOTTOM VIEW



SIDE VIEW



RECOMMENDED LAND PATTERN (Unit: mm)



DETAIL A

Pin #1 ID and Tie Bar Mark Options

NOTE: The configuration of the Pin #1 identifier is optional, but must be located within the zone indicated.

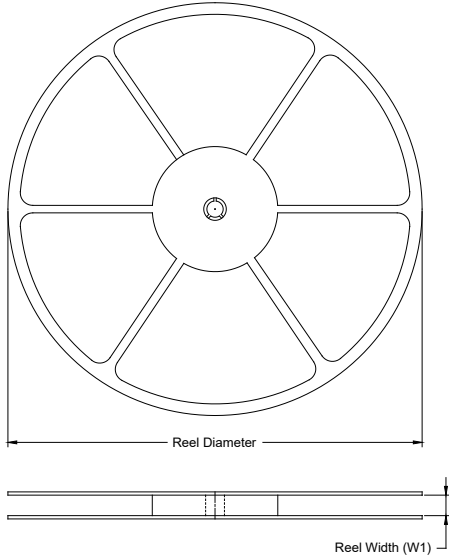
Symbol	Dimensions In Millimeters		Dimensions In Inches	
	MIN	MAX	MIN	MAX
A	0.700	0.800	0.028	0.031
A1	0.000	0.050	0.000	0.002
A2	0.203 REF		0.008 REF	
D	1.900	2.100	0.075	0.083
D1	1.100	1.450	0.043	0.057
E	1.900	2.100	0.075	0.083
E1	0.600	0.850	0.024	0.034
k	0.200 MIN		0.008 MIN	
b	0.180	0.300	0.007	0.012
e	0.650 TYP		0.026 TYP	
L	0.250	0.450	0.010	0.018



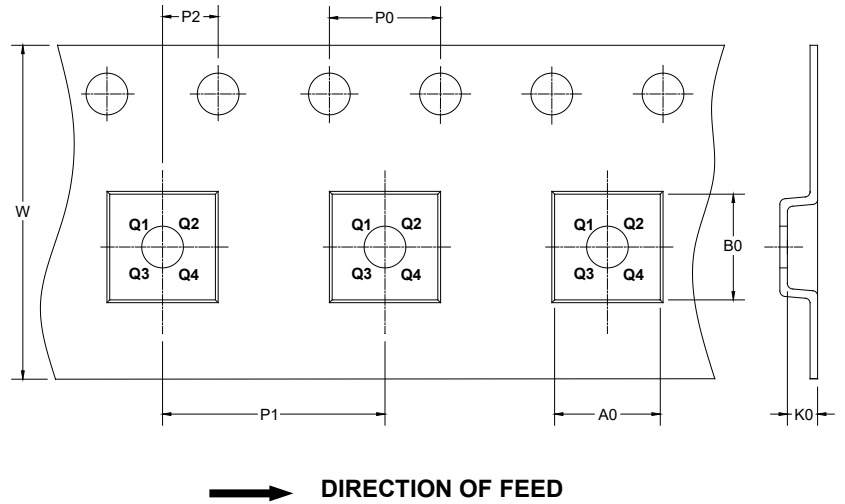
# PACKAGE INFORMATION

## TAPE AND REEL INFORMATION

### REEL DIMENSIONS



### TAPE DIMENSIONS



NOTE: The picture is only for reference. Please make the object as the standard.

### KEY PARAMETER LIST OF TAPE AND REEL

Package Type	Reel Diameter	Reel Width W1 (mm)	A0 (mm)	B0 (mm)	K0 (mm)	P0 (mm)	P1 (mm)	P2 (mm)	W (mm)	Pin1 Quadrant
TDFN-2×2-6L	7"	9.5	2.30	2.30	1.10	4.0	4.0	2.0	8.0	Q1

DD0001

# PACKAGE INFORMATION

## CARTON BOX DIMENSIONS



NOTE: The picture is only for reference. Please make the object as the standard.

## KEY PARAMETER LIST OF CARTON BOX

Reel Type	Length (mm)	Width (mm)	Height (mm)	Pizza/Carton
7" (Option)	368	227	224	8
7"	442	410	224	18

DD0002