

### GENERAL DESCRIPTION

The SGM31323 is a 3-channel, current-regulated RGB LED driver with an I<sup>2</sup>C-compatible interface. It is well suited for various applications powered by a 1-cell Li-Ion or Li-Polymer, or systems with 3.3V or 5V supply voltages, as well as 3-cell NiCd, NiMH or Alkaline batteries. No external components are required for the three constant current sinks.

With two programmable timers, users can adjust LED blinking time and get the result of fade-in and fade-out for unique color lighting.

Programmable I<sup>2</sup>C interface allows independent channel control for LED ON or OFF state and LED brightness due to 9 internal registers and an internal decoder. Each current sink can be independently configured with 192-step current levels from 0.125mA to 24mA. The SGM31323 provides less than 1µA shutdown current.

The SGM31323 is available in a Green UTDFN-1.5×1.5-8L package. It operates over an ambient temperature range of -40°C to +85°C.

### FEATURES

- **Input Voltage Range: 2.5V to 5.5V**
- **Ultra-Low 30mV Dropout Voltage at a 10mA Load per String**
- **Programmable LED Current through I<sup>2</sup>C Interface**
- **0.125mA to 24mA Current Levels with 0.125mA Steps**
- **Independent Channel Control**
  - **ON/OFF State Interval Time Control**
  - **RGB LED Color Control**
  - **Programmable Ramp-Up and Ramp-Down Time**
- **No Noise and Constant LED Current**
- **Fast and Smooth Startup**
- **Less than 1µA Shutdown Current**
- **-40°C to +85°C Operating Temperature Range**
- **Available in a Green UTDFN-1.5×1.5-8L Package**

### APPLICATIONS

- Multi-Color LEDs
- RGB Indicator LEDs
- Impact LED Signs and Displays
- Handheld Equipment

### TYPICAL APPLICATION

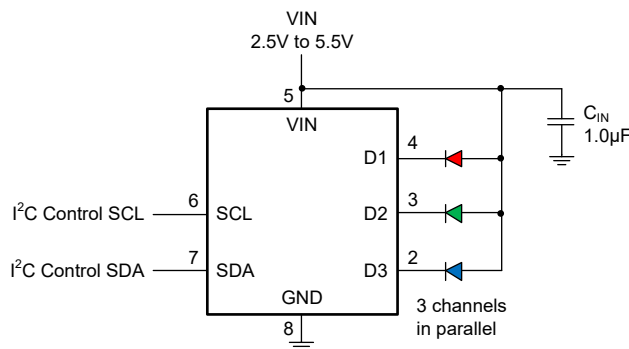

Figure 1. Typical Application Circuit

**PACKAGE/ORDERING INFORMATION**

MODEL	PACKAGE DESCRIPTION	SPECIFIED TEMPERATURE RANGE	ORDERING NUMBER	PACKAGE MARKING	PACKING OPTION
SGM31323	UTDFN-1.5×1.5-8L	-40°C to +85°C	SGM31323YUDW8G/TR	GJA XXX	Tape and Reel, 4000

**MARKING INFORMATION**

NOTE: XXX = Date Code.

**GJA** — Serial Number

**X XX**

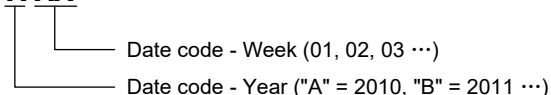

Green (RoHS & HSF): SG Micro Corp defines "Green" to mean Pb-Free (RoHS compatible) and free of halogen substances. If you have additional comments or questions, please contact your SGMICRO representative directly.

**ABSOLUTE MAXIMUM RATINGS**

- VIN, D1, D2, D3 to GND .....-0.3V to 6V
- SCL, SDA to GND .....-0.3V to VIN + 0.3V
- Package Thermal Resistance
- UTDFN-1.5×1.5-8L, θJA ..... 99.5°C/W
- Junction Temperature .....+150°C
- Storage Temperature Range ..... -65°C to +150°C
- Lead Temperature (Soldering, 10s) .....+260°C
- ESD Susceptibility
- HBM .....4000V
- MM .....400V
- CDM .....1000V

**RECOMMENDED OPERATING CONDITIONS**

- Input Voltage Range .....2.5V to 5.5V
- Operating Temperature Range ..... -40°C to +85°C

**OVERSTRESS CAUTION**

Stresses beyond those listed may cause permanent damage to the device. Functional operation of the device at these or any other conditions beyond those indicated in the operational section of the specification is not implied. Exposure to absolute maximum rating conditions for extended periods may affect reliability.

**ESD SENSITIVITY CAUTION**

This integrated circuit can be damaged by ESD if you don't pay attention to ESD protection. SGMICRO recommends that all integrated circuits be handled with appropriate precautions. Failure to observe proper handling and installation procedures can cause damage. ESD damage can range from subtle performance degradation to complete device failure. Precision integrated circuits may be more susceptible to damage because very small parametric changes could cause the device not to meet its published specifications.

**DISCLAIMER**

SG Micro Corp reserves the right to make any change in circuit design, specification or other related things if necessary without notice at any time.

## PIN CONFIGURATION

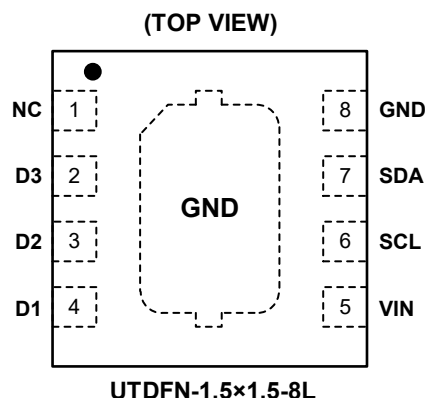

## PIN DESCRIPTION

NAME	PIN	TYPE	FUNCTION
NC	1	—	No Connection.
D3	2	O	Current Sink 3. The LED current level and ON/OFF states can be set by I <sup>2</sup> C interface.
D2	3	O	Current Sink 2. The LED current level and ON/OFF states can be set by I <sup>2</sup> C interface.
D1	4	O	Current Sink 1. Current level and ON/OFF selections are controlled by serial interface.
VIN	5	P	Input Supply Pin.
SCL	6	I	I <sup>2</sup> C Clock Signal.
SDA	7	I/O	I <sup>2</sup> C Data Signal.
GND	8	G	Ground Pin.
GND	Exposed Pad	—	Exposed Pad. It should be soldered to the ground.

NOTE: I: input; O: output; I/O: input or output; G: ground; P: power for the circuit.

**ELECTRICAL CHARACTERISTICS**(V<sub>IN</sub> = 3.6V, Full = -40°C to +85°C, typical values are at T<sub>A</sub> = +25°C, unless otherwise noted.)

PARAMETER	SYMBOL	CONDITIONS	TEMP	MIN	TYP	MAX	UNITS
<b>Power Supply</b>							
Input Operating Range	V <sub>IN</sub>		Full	2.5		5.5	V
Sink Pin (Dx) Dropout Voltage (90% of Nominal Current)	V <sub>D_MIN</sub>	All channels set to 24mA, REG6-8 = BFh	+25°C		65	90	mV
Output Current Accuracy		All channels set to 10mA, REG6-8 = 4Fh	+25°C	-5		5	%
Output Current Matching		Max( I <sub>Dx</sub> - I <sub>AVG</sub>  )/I <sub>AVG</sub> , all channels set to 10mA, REG6-8 = 4Fh	+25°C	-5		5	%
Supply Current	I <sub>IN</sub>	All channels set to 20mA, REG6-8 = 9Fh	+25°C		280	340	μA
		One channel set to 20mA, other channels off	+25°C		120	150	
Quiescent Current	I <sub>Q</sub>	Device on, all LEDs OFF, REG4 = 0	+25°C		41	52	μA
Shutdown Current	I <sub>SHDN</sub>	V <sub>IN</sub> = V <sub>OUT</sub> = 3.6V, SCL = 0V, SDA = 0V	+25°C		0.3	1	μA
<b>SCL and SDA</b>							
Input Logic Low Threshold	V <sub>IL</sub>	SDA, SCL	+25°C			0.4	V
Input Logic High Threshold	V <sub>IH</sub>	SDA, SCL	+25°C	1.2			V
<b>SCL and SDA Timing Specifications</b>							
SCL (Clock Period)	t <sub>1</sub>		+25°C	2.5			μs
Low Period of The SCL Clock	t <sub>2</sub>		+25°C	1.3			μs
DATA_IN Setup Time to SCL High	t <sub>3</sub>		+25°C	350			ns
DATA_IN Hold Time after SCL Low	t <sub>4</sub>		+25°C	0		0.8	μs
DATA_OUT Stable after SCL Low	t <sub>5</sub>		+25°C	350			ns
SDA Low Setup Time to SCL Low (Start)	t <sub>6</sub>		+25°C	600			ns
SCL High Setup Time to SDA High (Stop)	t <sub>7</sub>		+25°C	600			ns
<b>Thermal Shutdown</b>							
Thermal Shutdown Threshold					140		°C
Thermal Shutdown Hysteresis					15		°C

TYPICAL PERFORMANCE CHARACTERISTICS

T<sub>A</sub> = +25°C, V<sub>IN</sub> = 3.6V, C<sub>IN</sub> = 1μF, unless otherwise noted.

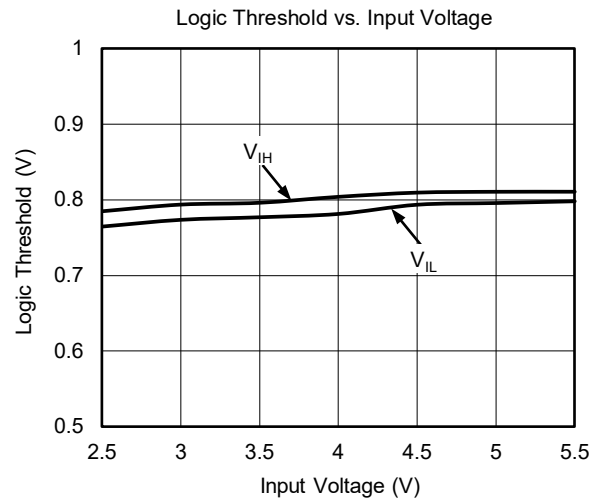
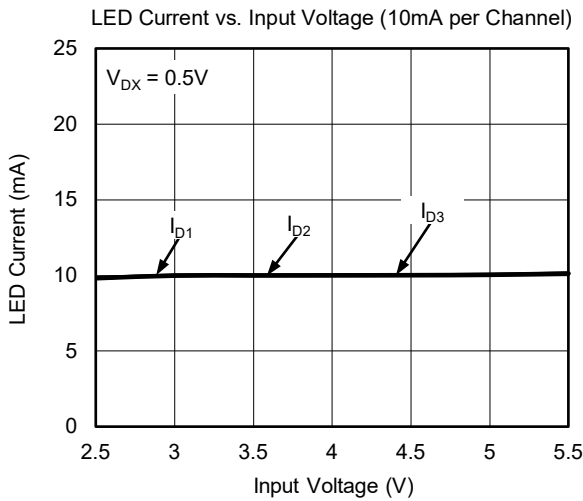
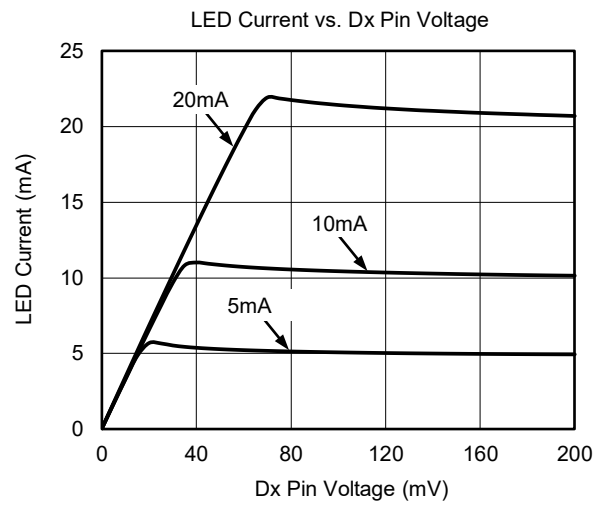
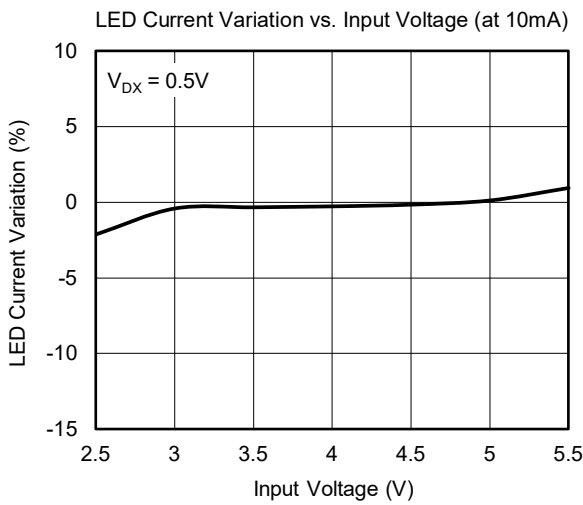
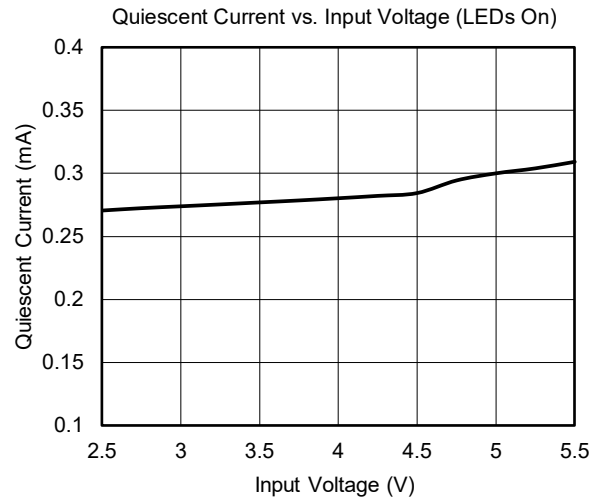
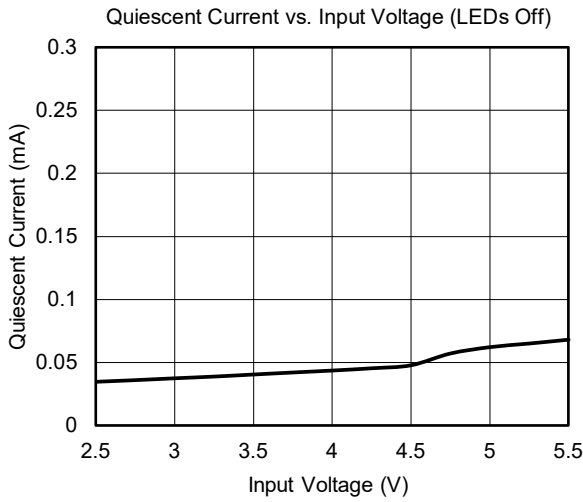

TYPICAL PERFORMANCE CHARACTERISTICS (continued)

T<sub>A</sub> = +25°C, V<sub>IN</sub> = 3.6V, C<sub>IN</sub> = 1µF, unless otherwise noted.

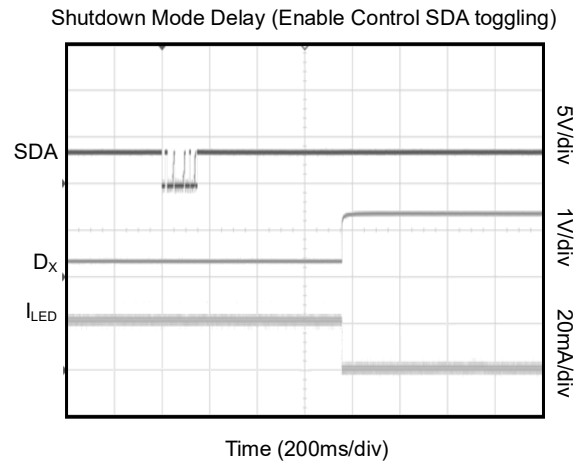
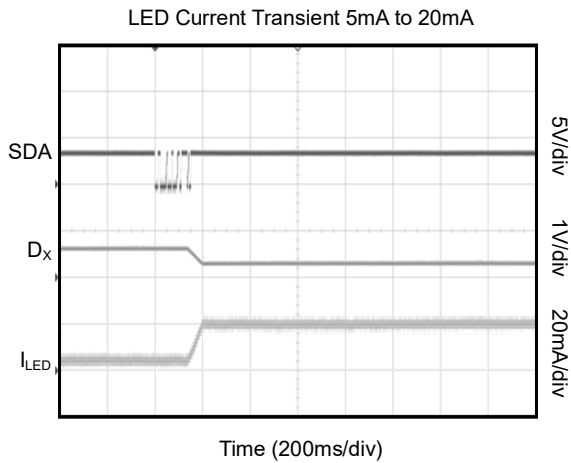
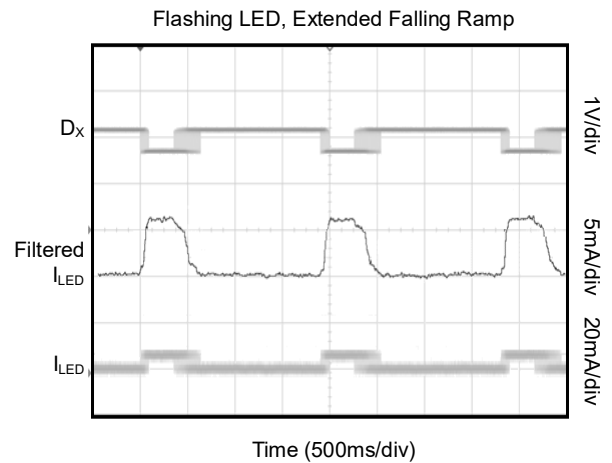
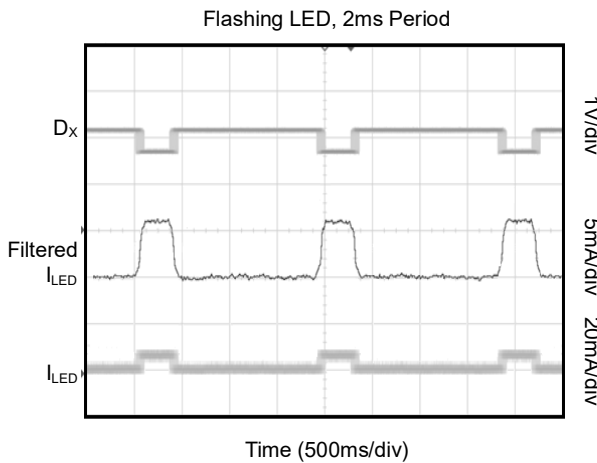
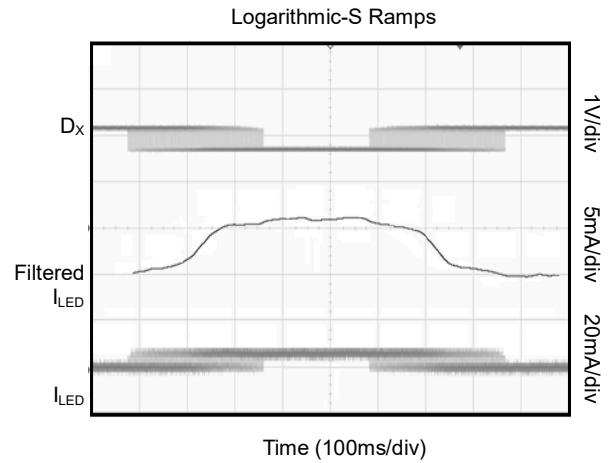
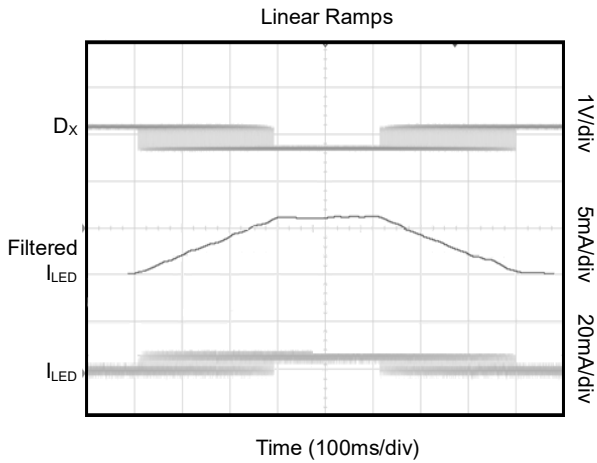

I<sup>2</sup>C INTERFACE

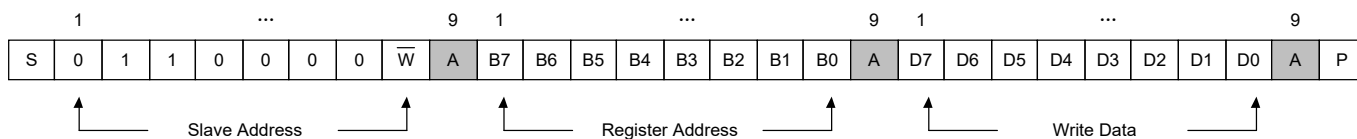

Figure 2. I<sup>2</sup>C Write Sequence for a Single Register

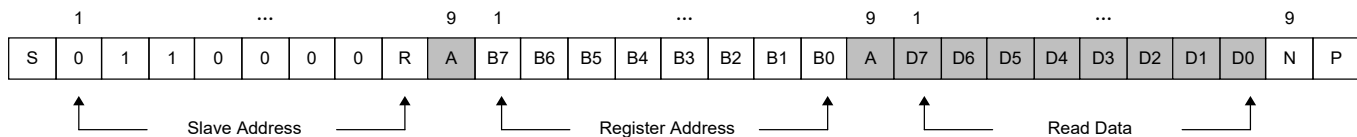

Figure 3. I<sup>2</sup>C Read Sequence for a Single Register

NOTES:

1. □ By Master, ■ By Slave.

S: Start, P: Stop, W: Write, R: Read, A: Acknowledge (SDA Low), N: Not Acknowledge (SDA High).

## REGISTER MAP

All registers are 8-bit and individual bits are named from D[0] (LSB) to D[7] (MSB).

R/W: Read/Write bit(s)  
R: Read only bit(s)  
PORV: Power-On Reset Value

Table 1. Register Map

REGISTER NAME	FUNCTION	D[7]	D[6]	D[5]	D[4]	D[3]	D[2]	D[1]	D[0]
REG0	Enable/Reset	TEST_FAC	TM_SCAL[1:0]		EN_CTRL[1:0]		TS_RST_MODE[2:0]		
REG1	Flash Period	RAMP_LINE	FLASH_PERIOD[6:0]						
REG2	PWM1 Timer	PWM1_TM_PER[7:0]							
REG3	PWM2 Timer	PWM2_TM_PER[7:0]							
REG4	Channel Control	Reserved		LED3_EN_TM[1:0]		LED2_EN_TM[1:0]		LED1_EN_TM[1:0]	
REG5	Ramp Rate	RISE_TM[3:0]				FALL_TM[3:0]			
REG6	LED1 Current	I_LED1[7:0]							
REG7	LED2 Current	I_LED2[7:0]							
REG8	LED3 Current	I_LED3[7:0]							

## REG0

Table 2. REG0 Register Details

BITS	BIT NAME	DESCRIPTION	PORV
D[7]	TEST_FAC	Test Only. It should be set to 0.	0
D[6:5]	TM_SCAL[1:0]	Rise or Fall Scaling Factor 00 = 1× Normal (default) 01 = 2× Slower 10 = 4× Slower 11 = 8× Faster	00
D[4:3]	EN_CTRL[1:0]	Enable Control 00 = Device ON at SCL = high and SDA = high. When either SDA or SCL goes low, the device goes into shutdown mode. (default) 01 = Device ON at SCL = high and SDA toggling. When either SCL goes low or SDA stops toggling, the device goes into shutdown mode. 10 = Device ON at SCL = high regardless of SDA state. When SCL goes low, the device goes into shutdown mode. 11 = Device always ON.	00
D[2:0]	TS_RST_MODE[2:0]	Timer Slot Control and Reset Control 000 = TCtrl: Tslot1 (default) 001 = TCtrl: Tslot2 010 = TCtrl: Tslot3 011 = TCtrl: Tslot4 100 = Do Nothing (bit cleared) 101 = Reset Registers Only 110 = Reset Main Digital Only 111 = Reset Complete Chip	000

## NOTE:

1. The device goes into shutdown mode or sleep mode with a typically 600µs delay after the last SDA falling edge.



REGISTER DESCRIPTION (continued)

REG1

Table 3. REG1 Register Details

BITS	BIT NAME	DESCRIPTION	PORV
D[7]	RAMP_LINE	0 = a logarithmic-like S ramp-up and ramp-down curve. (default) 1 = a simple linear up and down curve.	0
D[6:0]	FLASH_PERIOD[6:0]	Flash Period Setting 0000000 = 0.128s (default) 0000001 = 0.384s 0000010 = 0.512s 0000011 = 0.640s 0000100 = 0.768s 0000101 = 0.896s 0000110 = 1.024s 0000111 = 1.152s 0001000 = 1.28s 0001001 = 1.408s 0001010 = 1.536s 0001011 = 1.664s 0001100 = 1.792s 0001101 = 1.92s ..... 1101111 = 14.46s 1110000 = 14.59s 1110001 = 14.72s 1110010 = 14.85s 1110011 = 14.98s 1110100 = 15.10s 1110101 = 15.23s 1110110 = 15.36s 1110111 = 15.49s 1111000 = 15.62s 1111001 = 15.74s 1111010 = 15.87s 1111011 = 16.0s 1111100 = 16.13s 1111101 = 16.26s 1111110 = 16.38s 1111111 = 16.51s	0000000

REGISTER DESCRIPTION (continued)

REG2

Table 4. REG2 Register Details

BITS	BIT NAME	DESCRIPTION	PORV
D[7:0]	PWM1_TM_PER[7:0]	Percentage of Period Setting for Flash ON Timer 1 00000000 = 0.0% 00000001 = 0.4% (default) 00000010 = 0.8% 00000011 = 1.2% 00000100 = 1.6% 00000101 = 2.0% 00000110 = 2.3% 00000111 = 2.7% 00001000 = 3.1% 00001001 = 3.5% 00001010 = 3.9% 00001011 = 4.3% 00001100 = 4.7% 00001101 = 5.1% ..... 11101111 = 93.4% 11110000 = 93.8% 11110001 = 94.1% 11110010 = 94.5% 11110011 = 94.9% 11110100 = 95.3% 11110101 = 95.7% 11110110 = 96.1% 11110111 = 96.5% 11111000 = 96.9% 11111001 = 97.3% 11111010 = 97.7% 11111011 = 98.0% 11111100 = 98.4% 11111101 = 98.8% 11111110 = 99.2% 11111111 = 99.6%  ON Timer 1 = the corresponding flash period × the corresponding percentage of period For example, if REG1 = 03h and REG2 = 05h, ON Timer 1 = 0.64s × 2% = 12.8ms	00000001

## REG3

Table 5. REG3 Register Details

BITS	BIT NAME	DESCRIPTION	PORV
D[7:0]	PWM2_TM_PER[7:0]	Percentage of Period Setting for Flash ON Timer 2 00000000 = 0.0% 00000001 = 0.4% (default) 00000010 = 0.8% 00000011 = 1.2% 00000100 = 1.6% 00000101 = 2.0% 00000110 = 2.3% 00000111 = 2.7% 00001000 = 3.1% 00001001 = 3.5% 00001010 = 3.9% 00001011 = 4.3% 00001100 = 4.7% 00001101 = 5.1% ..... 11101111 = 93.4% 11110000 = 93.8% 11110001 = 94.1% 11110010 = 94.5% 11110011 = 94.9% 11110100 = 95.3% 11110101 = 95.7% 11110110 = 96.1% 11110111 = 96.5% 11111000 = 96.9% 11111001 = 97.3% 11111010 = 97.7% 11111011 = 98.0% 11111100 = 98.4% 11111101 = 98.8% 11111110 = 99.2% 11111111 = 99.6%  ON Timer 2 = the corresponding flash period × the corresponding percentage of period For example, if REG1 = 03h and REG3 = 05h, ON Timer 2 = 0.64s × 2% = 12.8ms	00000001

## REG4

Table 6. REG4 Register Details

BITS	BIT NAME	DESCRIPTION	PORV
D[7:6]	Reserved	Reserved	00
D[5:4]	LED3_EN_TM[1:0]	LED3 Mode Setting 00 = Always OFF (default) 01 = Always ON 10 = PWM1 11 = PWM2	00
D[3:2]	LED2_EN_TM[1:0]	LED2 Mode Setting 00 = Always OFF (default) 01 = Always ON 10 = PWM1 11 = PWM2	00
D[1:0]	LED1_EN_TM[1:0]	LED1 Mode Setting 00 = Always OFF (default) 01 = Always ON 10 = PWM1 11 = PWM2	00

## REGISTER DESCRIPTION (continued)

## REG5

Table 7. REG5 Register Details

BITS	BIT NAME	DESCRIPTION	PORV
D[7:4]	RISE_TM[3:0]	<p><math>t_{RISE}</math> Time Setting FAC is defined as the corresponding scaling factor setting value of TM_SCAL[1:0]. FAC can be set to 1, 2, 4, or 1/8. Only one scaling register is for both rise and fall time.</p> <p>0000 = 1.5ms 0001 = 96ms × FAC 0010 = 192ms × FAC 0011 = 288ms × FAC 0100 = 384ms × FAC 0101 = 480ms × FAC 0110 = 576ms × FAC 0111 = 672ms × FAC 1000 = 768ms × FAC 1001 = 864ms × FAC 1010 = 960ms × FAC 1011 = 1056ms × FAC 1100 = 1152ms × FAC 1101 = 1248ms × FAC 1110 = 1344ms × FAC 1111 = 1440ms × FAC</p> <p>For example, if RISE_TM[3:0] = 0100 and TM_SCAL[1:0] = 00, so FAC = 1, <math>t_{RISE}</math> = 384ms × 1 = 384ms.</p>	0000
D[3:0]	FALL_TM[3:0]	<p><math>t_{FALL}</math> Time Setting FAC is defined as the corresponding scaling factor setting value of TM_SCAL[1:0]. FAC can be set to 1, 2, 4, or 1/8. Only one scaling register is for both rise and fall time.</p> <p>0000 = 1.5ms 0001 = 96ms × FAC 0010 = 192ms × FAC 0011 = 288ms × FAC 0100 = 384ms × FAC 0101 = 480ms × FAC 0110 = 576ms × FAC 0111 = 672ms × FAC 1000 = 768ms × FAC 1001 = 864ms × FAC 1010 = 960ms × FAC 1011 = 1056ms × FAC 1100 = 1152ms × FAC 1101 = 1248ms × FAC 1110 = 1344ms × FAC 1111 = 1440ms × FAC</p> <p>For example, if FALL_TM[3:0] = 0100 and TM_SCAL[1:0] = 00, so FAC = 1, <math>t_{RISE}</math> = 384ms × 1 = 384ms.</p>	0000

REGISTER DESCRIPTION (continued)

REG6

Table 8. REG6 Register Details

BITS	BIT NAME	DESCRIPTION	PORV
D[7:0]	I_LED1[7:0]	LED1 Current Setting 00000000 = 0.125ms 00000001 = 0.25ms 00000010 = 0.38ms 00000011 = 0.50ms ..... 01001111 = 10.00ms 01010000 = 10.13ms ..... 10011111 = 20.00ms 10100000 = 20.13ms ..... 10111110 = 23.88ms 10111111 = 24.00ms 11000000 = 24.00ms ..... 11111110 = 24.00ms 11111111 = 24.00ms	01001111

REG7

Table 9. REG7 Register Details

BITS	BIT NAME	DESCRIPTION	PORV
D[7:0]	I_LED2[7:0]	LED2 Current Setting 00000000 = 0.125ms 00000001 = 0.25ms 00000010 = 0.38ms 00000011 = 0.50ms ..... 01001111 = 10.00ms 01010000 = 10.13ms ..... 10011111 = 20.00ms 10100000 = 20.13ms ..... 10111110 = 23.88ms 10111111 = 24.00ms 11000000 = 24.00ms ..... 11111110 = 24.00ms 11111111 = 24.00ms	01001111

**REGISTER DESCRIPTION (continued)**

**REG8**

Table 10. REG8 Register Details

BITS	BIT NAME	DESCRIPTION	PORV
D[7:0]	I_LED3[7:0]	LED3 Current Setting 00000000 = 0.125ms 00000001 = 0.25ms 00000010 = 0.38ms 00000011 = 0.50ms ..... 01001111 = 10.00ms 01010000 = 10.13ms ..... 10011111 = 20.00ms 10100000 = 20.13ms ..... 10111110 = 23.88ms 10111111 = 24.00ms 11000000 = 24.00ms ..... 11111110 = 24.00ms 11111111 = 24.00ms	01001111

**REVISION HISTORY**

NOTE: Page numbers for previous revisions may differ from page numbers in the current version.

**JUNE 2018 – REV.A to REV.A.1**

Added package thermal resistance ..... 2

**Changes from Original (JULY 2017) to REV.A**

Changed from product preview to production data ..... All

PACKAGE OUTLINE DIMENSIONS

UTDFN-1.5x1.5-8L

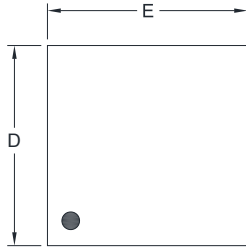

TOP VIEW

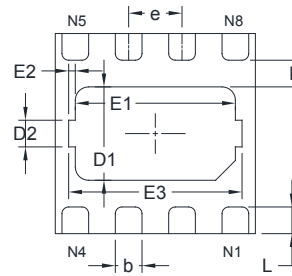

BOTTOM VIEW

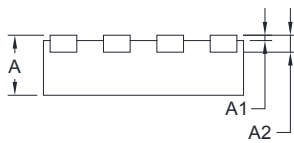

SIDE VIEW

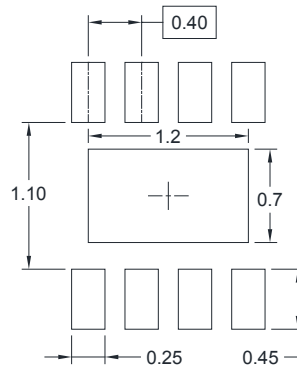

RECOMMENDED LAND PATTERN

Symbol	Dimensions In Millimeters		Dimensions In Inches	
	MIN	MAX	MIN	MAX
A	0.400	0.500	0.016	0.020
A1	0.000	0.050	0.000	0.002
A2	0.127 REF		0.005 REF	
D	1.450	1.550	0.057	0.061
D1	0.600	0.800	0.024	0.031
D2	0.200 REF		0.008 REF	
E	1.450	1.550	0.057	0.061
E1	1.100	1.300	0.043	0.051
E2	0.050 REF		0.002 REF	
E3	1.200	1.400	0.047	0.055
k	0.200 REF		0.008 REF	
b	0.150	0.250	0.006	0.010
e	0.400 BSC		0.016 BSC	
L	0.150	0.250	0.006	0.010

# PACKAGE INFORMATION

## TAPE AND REEL INFORMATION

### REEL DIMENSIONS



### TAPE DIMENSIONS



NOTE: The picture is only for reference. Please make the object as the standard.

### KEY PARAMETER LIST OF TAPE AND REEL

Package Type	Reel Diameter	Reel Width W1 (mm)	A0 (mm)	B0 (mm)	K0 (mm)	P0 (mm)	P1 (mm)	P2 (mm)	W (mm)	Pin1 Quadrant
UTDFN-1.5×1.5-8L	7"	9.0	1.70	1.70	0.75	4.0	4.0	2.0	8.0	Q1

000001



# PACKAGE INFORMATION

## CARTON BOX DIMENSIONS



NOTE: The picture is only for reference. Please make the object as the standard.

## KEY PARAMETER LIST OF CARTON BOX

Reel Type	Length (mm)	Width (mm)	Height (mm)	Pizza/Carton
7" (Option)	368	227	224	8
7"	442	410	224	18

DD0002