

GENERAL DESCRIPTION

The SGM3110 is a regulated switched-capacitor boost converter with low-power consumption. This device is characterized by very low quiescent current. There is no need to connect inductors outside the chip. The small package size makes the device very suitable for space limited applications.

Different input voltages can produce a regulated output voltage. It is capable of supplying 100mA output current.

SGM3110 has thermal shutdown function to protect the equipment under short-circuit conditions.

The SGM3110 is available in a Green SOT-23-6 package and is rated over the -40 °C to +85 °C temperature range.

FEATURES

- **Input Voltage Range:**
 - SGM3110-5.0: 2.7V to 5.0V**
 - SGM3110-4.5: 2.7V to 4.5V**
- **Boost Converter**
- **Quiescent Current: 60µA (TYP)**
- **4.5V and 5V Regulated Output Voltages with ±4% Accuracy**
- **250mA Peak Current for 100ms**
- **750kHz Switching Frequency**
- **Logic-Controlled Shutdown**
- **Integrated Protection Features:**
 - ◆ **Short-Circuit Protection**
 - ◆ **Over-Temperature Protection**
- **Available in a Green SOT-23-6 Package**

APPLICATIONS

- PDA's
- GPS Receivers
- Cellular Phones
- Digital Cameras
- Handheld Electronics
- LED Backlight Drivers
- Portable Communication Devices

TYPICAL APPLICATION

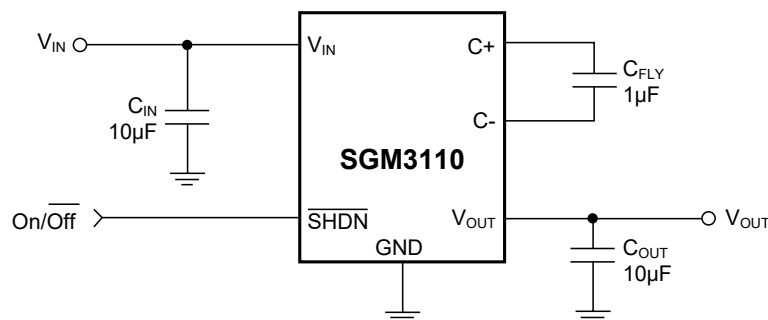

PACKAGE/ORDERING INFORMATION

MODEL	PACKAGE DESCRIPTION	SPECIFIED TEMPERATURE RANGE	ORDERING NUMBER	PACKAGE MARKING	PACKING OPTION
SGM3110-4.5	SOT-23-6	-40°C to +85°C	SGM3110-4.5YN6/TR	3110A	Tape and Reel, 3000
SGM3110-5.0	SOT-23-6	-40°C to +85°C	SGM3110-5.0YN6/TR	3110	Tape and Reel, 3000

Green (RoHS & HSF): SG Micro Corp defines "Green" to mean Pb-Free (RoHS compatible) and free of halogen substances. If you have additional comments or questions, please contact your SGMICRO representative directly.

ABSOLUTE MAXIMUM RATINGS

V_{IN} to GND	-0.3V to 6V
V_{OUT} to GND	-0.3V to 6V
\overline{SHDN} to GND	-0.3V to 6V
Power Dissipation, P_D @ $T_A = +25^\circ\text{C}$	
SOT-23-6	0.34W
Package Thermal Resistance	
SOT-23-6, θ_{JA}	250°C/W
Junction Temperature	+150°C
Storage Temperature Range.....	-65°C to +150°C
Lead Temperature (Soldering, 10s)	+260°C
ESD Susceptibility	
HBM.....	2000V
MM.....	400V

RECOMMENDED OPERATING CONDITIONS

Operating Temperature Range	-40°C to +85°C
-----------------------------------	----------------

OVERSTRESS CAUTION

Stresses beyond those listed in Absolute Maximum Ratings may cause permanent damage to the device. Exposure to absolute maximum rating conditions for extended periods may affect reliability. Functional operation of the device at any conditions beyond those indicated in the Recommended Operating Conditions section is not implied.

ESD SENSITIVITY CAUTION

This integrated circuit can be damaged if ESD protections are not considered carefully. SGMICRO recommends that all integrated circuits be handled with appropriate precautions. Failure to observe proper handling and installation procedures can cause damage. ESD damage can range from subtle performance degradation to complete device failure. Precision integrated circuits may be more susceptible to damage because even small parametric changes could cause the device not to meet the published specifications.

DISCLAIMER

SG Micro Corp reserves the right to make any change in circuit design, or specifications without prior notice.

PIN CONFIGURATION

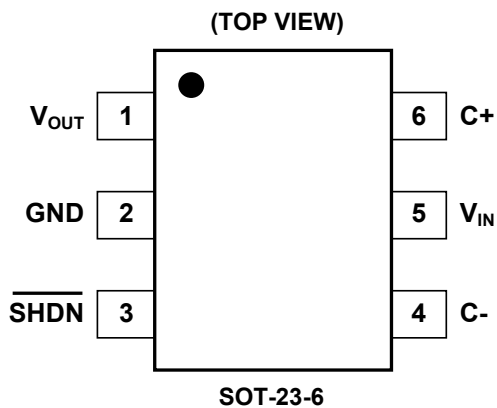

PIN DESCRIPTION

PIN	NAME	FUNCTION
1	V _{OUT}	Regulated Output Pin.
2	GND	Ground.
3	$\overline{\text{SHDN}}$	Shutdown Input Pin. Logic low to shut down the device.
4	C-	Negative Terminal of the Flying Capacitor.
5	V _{IN}	Input Power Supply Pin.
6	C+	Positive Terminal of the Flying Capacitor.

ELECTRICAL CHARACTERISTICS

(At $T_A = -40^\circ\text{C}$ to $+85^\circ\text{C}$, $C_{FLY} = 1\mu\text{F}$, $C_{IN} = 10\mu\text{F}$ and $C_{OUT} = 10\mu\text{F}$. Typical values are at $T_A = +25^\circ\text{C}$, unless otherwise noted.)

PARAMETER	SYMBOL	CONDITIONS	MIN	TYP	MAX	UNITS
SGM3110-5.0						
Input Voltage Range	V_{IN}	$V_{OUT} = 5.0\text{V}$	2.7		V_{OUT}	V
Output Voltage	V_{OUT}	$2.7\text{V} < V_{IN} < 5\text{V}$, $I_{OUT} \leq 50\text{mA}$	4.8	5.0	5.2	V
		$3.0\text{V} < V_{IN} < 5\text{V}$, $I_{OUT} \leq 100\text{mA}$	4.8	5.0	5.2	
Quiescent Current	I_Q	$2.7\text{V} < V_{IN} < 5\text{V}$, $I_{OUT} = 0\text{mA}$, $\overline{\text{SHDN}} = V_{IN}$		60	68	μA
Shutdown Supply Current	I_{SHDN}	$2.7\text{V} < V_{IN} < 3.6\text{V}$, $I_{OUT} = 0\text{mA}$, $V_{SHDN} = 0$		0.2	1	μA
		$3.6\text{V} < V_{IN} < 5\text{V}$, $I_{OUT} = 0\text{mA}$, $V_{SHDN} = 0$			1	
Ripple Voltage	V_{RIPPLE}	$V_{IN} = 2.7\text{V}$, $I_{OUT} = 50\text{mA}$		15		mV_{P-P}
		$V_{IN} = 3\text{V}$, $I_{OUT} = 100\text{mA}$		88		
Efficiency	η	$V_{IN} = 2.7\text{V}$, $I_{OUT} = 50\text{mA}$		91		%
Frequency	f_{OSC}	Oscillator Free Running		750		kHz
$\overline{\text{SHDN}}$ Input Threshold High	V_{IH}		1.4			V
$\overline{\text{SHDN}}$ Input Threshold Low	V_{IL}				0.4	
$\overline{\text{SHDN}}$ Input High Current	I_{IH}	$\overline{\text{SHDN}} = V_{IN}$	-1		+1	μA
$\overline{\text{SHDN}}$ Input Low Current	I_{IL}	$\overline{\text{SHDN}} = \text{GND}$	-1		+1	μA
Turn-On Time	t_{ON}	$V_{IN} = 3\text{V}$, $I_{OUT} = 0\text{mA}$		0.3		ms
SGM3110-4.5						
Input Voltage Range	V_{IN}	$V_{OUT} = 4.5\text{V}$	2.7		V_{OUT}	V
Output Voltage	V_{OUT}	$2.7\text{V} < V_{IN} < 4.5\text{V}$, $I_{OUT} \leq 50\text{mA}$	4.32	4.5	4.68	V
		$3.0\text{V} < V_{IN} < 4.5\text{V}$, $I_{OUT} \leq 100\text{mA}$	4.32	4.5	4.68	
Quiescent Current	I_Q	$2.7\text{V} < V_{IN} < 4.5\text{V}$, $I_{OUT} = 0\text{mA}$, $\overline{\text{SHDN}} = V_{IN}$		60	68	μA
Shutdown Supply Current	I_{SHDN}	$2.7\text{V} < V_{IN} < 3.6\text{V}$, $I_{OUT} = 0\text{mA}$, $V_{SHDN} = 0$		0.2	1	μA
		$3.6\text{V} < V_{IN} < 4.5\text{V}$, $I_{OUT} = 0\text{mA}$, $V_{SHDN} = 0$			1	
Ripple Voltage	V_{RIPPLE}	$V_{IN} = 2.7\text{V}$, $I_{OUT} = 50\text{mA}$		15		mV_{P-P}
		$V_{IN} = 3\text{V}$, $I_{OUT} = 100\text{mA}$		88		
Efficiency	η	$V_{IN} = 2.7\text{V}$, $I_{OUT} = 50\text{mA}$		83		%
Frequency	f_{OSC}	Oscillator Free Running		750		kHz
$\overline{\text{SHDN}}$ Input Threshold High	V_{IH}		1.4			V
$\overline{\text{SHDN}}$ Input Threshold Low	V_{IL}				0.4	
$\overline{\text{SHDN}}$ Input High Current	I_{IH}	$\overline{\text{SHDN}} = V_{IN}$	-1		+1	μA
$\overline{\text{SHDN}}$ Input Low Current	I_{IL}	$\overline{\text{SHDN}} = \text{GND}$	-1		+1	μA
Turn-On Time	t_{ON}	$V_{IN} = 3\text{V}$, $I_{OUT} = 0\text{mA}$		0.3		ms

TYPICAL PERFORMANCE CHARACTERISTICS

At $T_A = +25^\circ\text{C}$, $V_S = 5\text{V}$, $V_{IN} = 3\text{V}$, $C_{IN} = C_{OUT} = 10\mu\text{F}$ and $C_{FLY} = 1\mu\text{F}$, unless otherwise noted.

Startup Time with 50mA Load

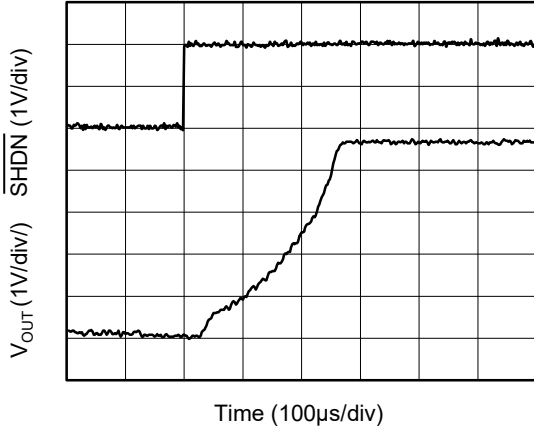

Startup Time with 100mA Load

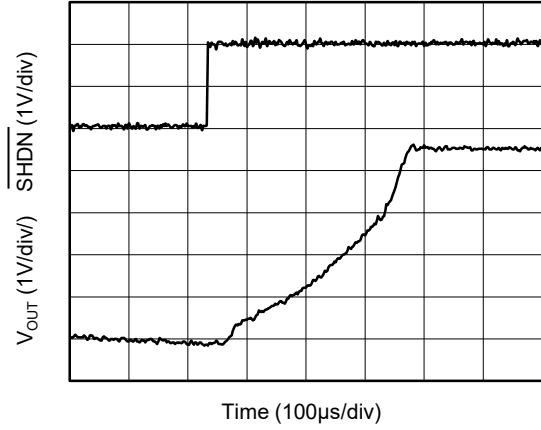

Output Ripple with I_{OUT} = 50mA

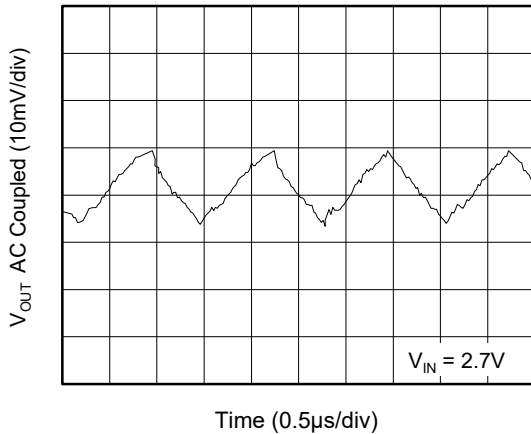

Output Ripple with I_{OUT} = 100mA

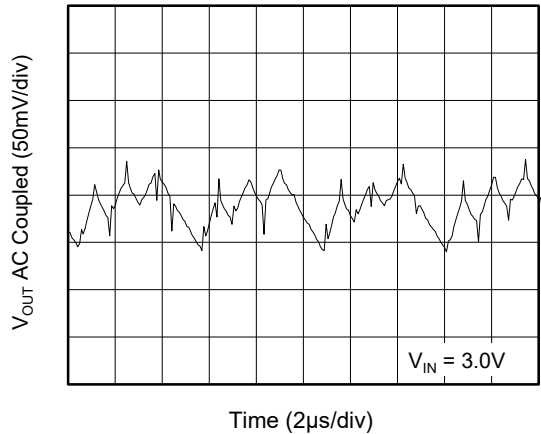

Load Transient Response for 50mA

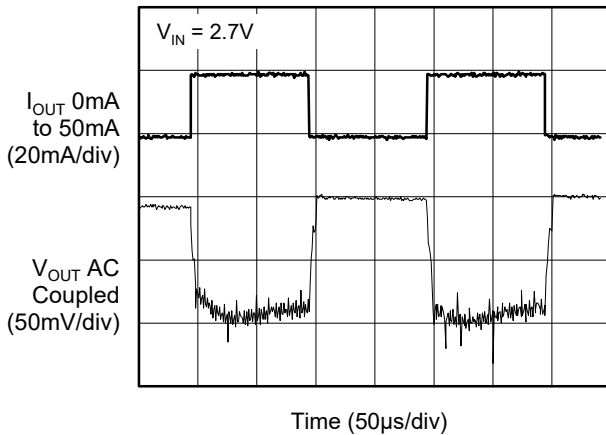

Load Transient Response for 100mA

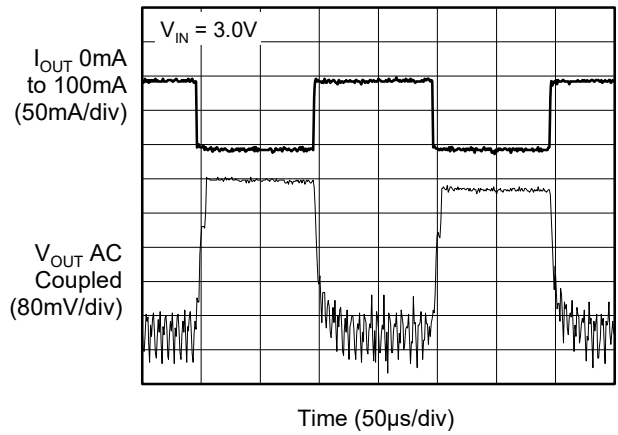

TYPICAL PERFORMANCE CHARACTERISTICS (continued)

At $T_A = +25^\circ\text{C}$, $V_S = 5\text{V}$, $V_{IN} = 3\text{V}$, $C_{IN} = C_{OUT} = 10\mu\text{F}$ and $C_{FLY} = 1\mu\text{F}$, unless otherwise noted.

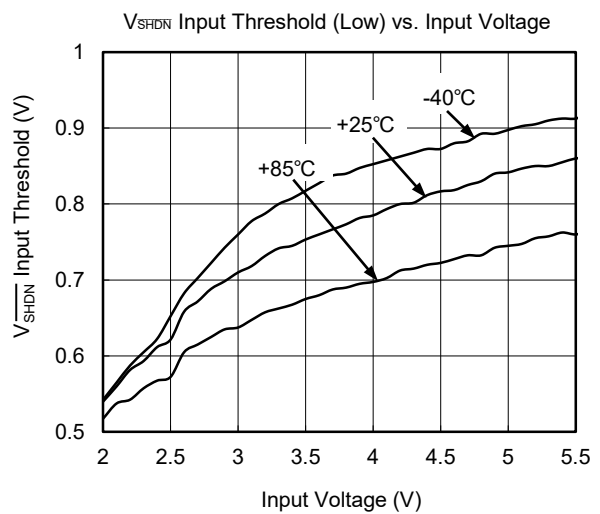
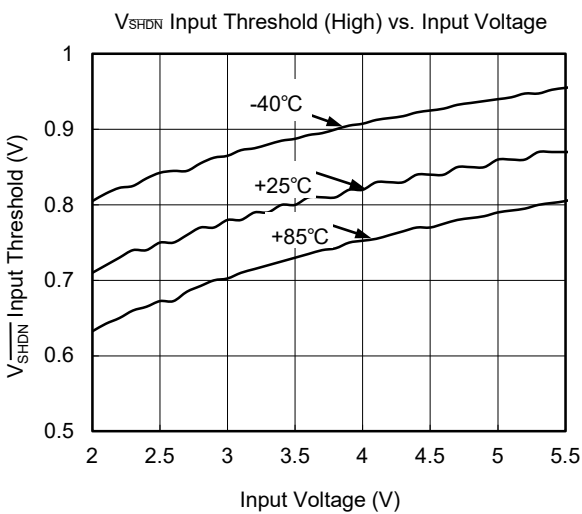
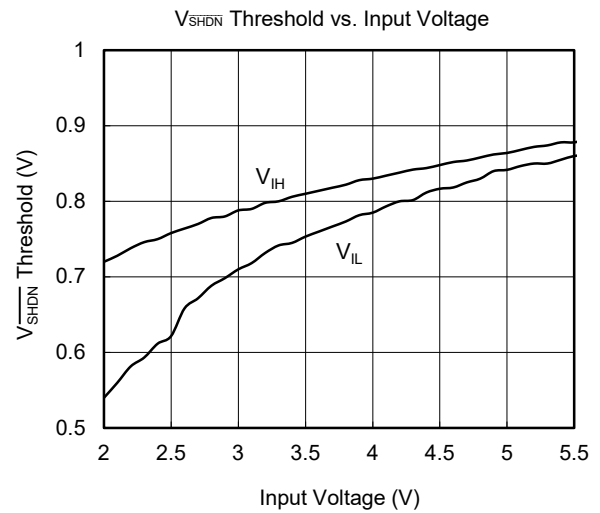
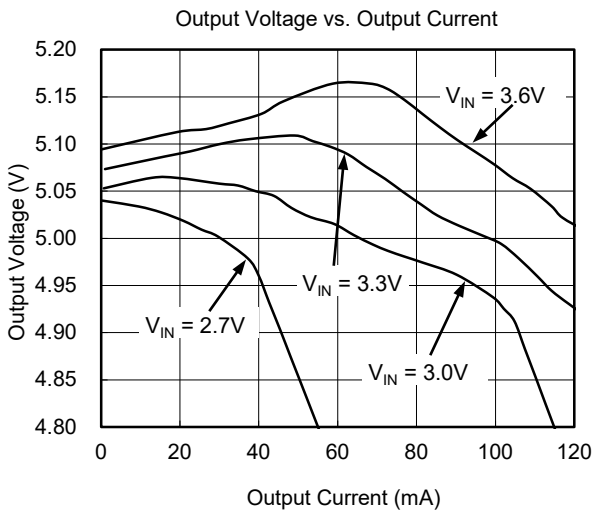
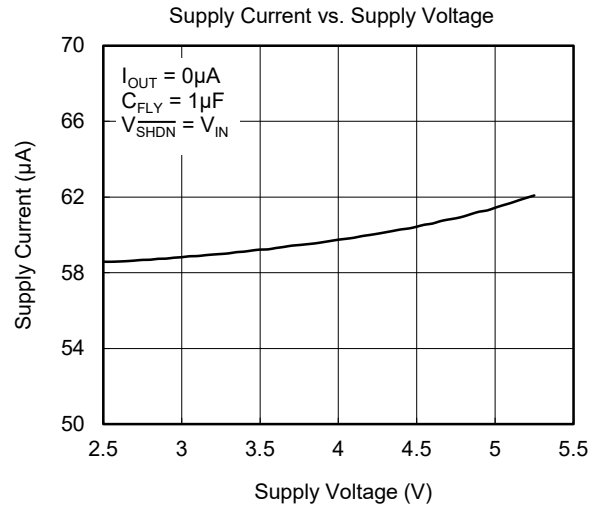
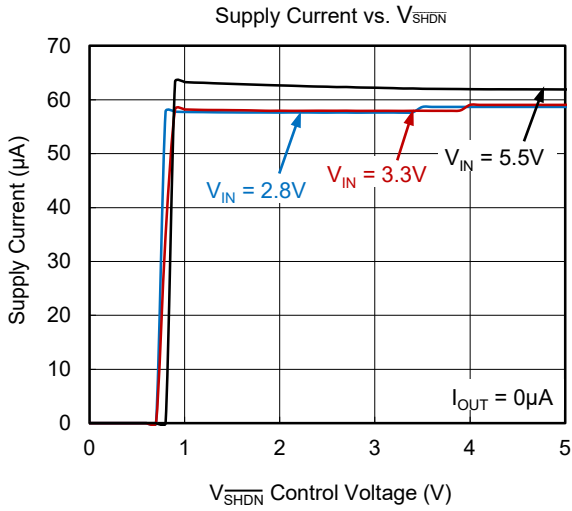

TYPICAL PERFORMANCE CHARACTERISTICS (continued)

At $T_A = +25^\circ\text{C}$, $V_S = 5\text{V}$, $V_{IN} = 3\text{V}$, $C_{IN} = C_{OUT} = 10\mu\text{F}$ and $C_{FLY} = 1\mu\text{F}$, unless otherwise noted.

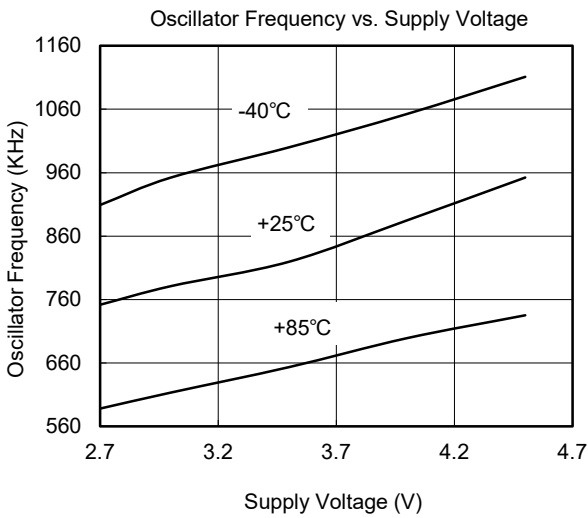
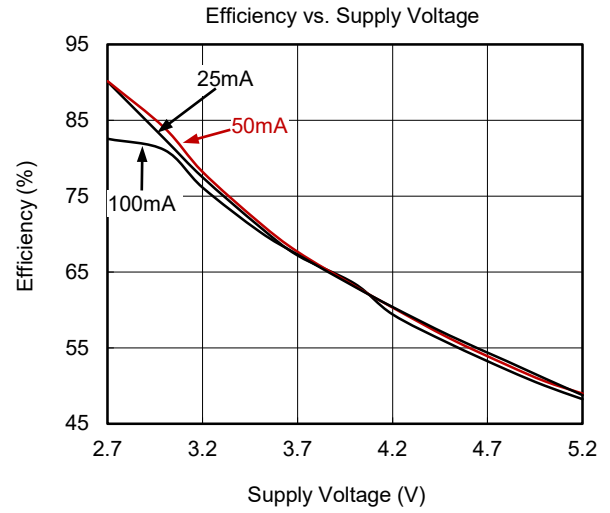
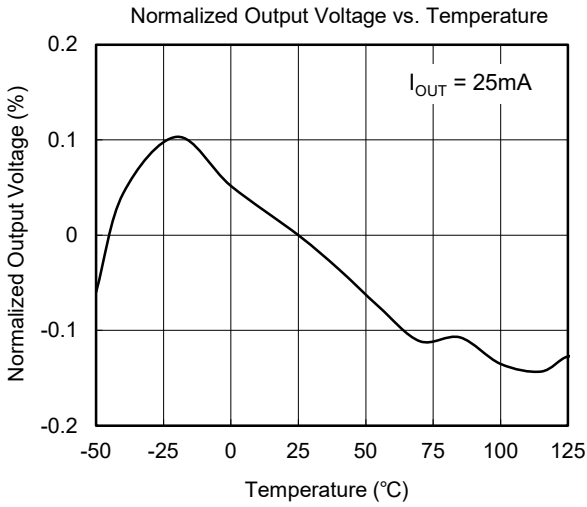

REVISION HISTORY

NOTE: Page numbers for previous revisions may differ from page numbers in the current version.

MARCH 2018 – REV.A.2 to REV.A.3

Added Functional Block Diagram section..... 8

JANUARY 2013 – REV.A.1 to REV.A.2

Added Recommended Land Pattern Information 8

Added Tape and Reel Information 9, 10

JUNE 2011 – REV.A to REV.A.1

Changed Typical Performance Characteristics section 7

Changes from Original (JANUARY 2009) to REV.A

Changed from product preview to production data..... All

PACKAGE OUTLINE DIMENSIONS

SOT-23-6

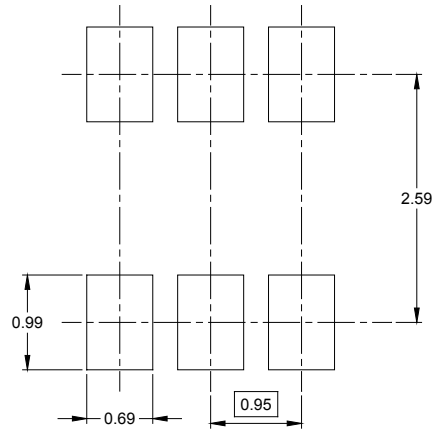
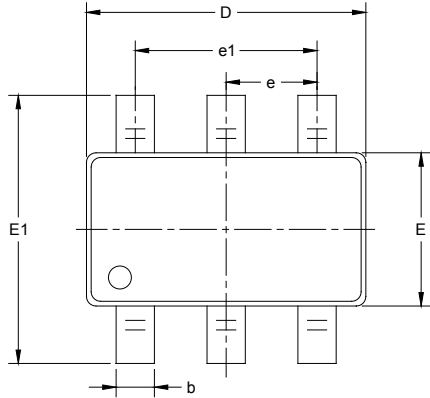

RECOMMENDED LAND PATTERN (Unit: mm)

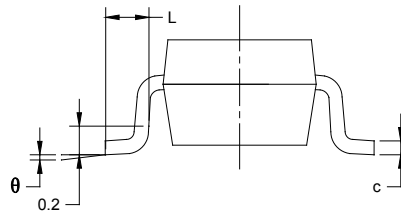
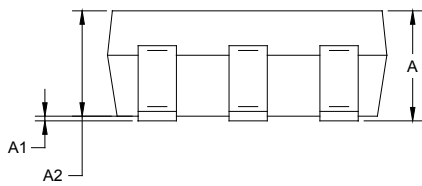

Symbol	Dimensions In Millimeters		Dimensions In Inches	
	MIN	MAX	MIN	MAX
A	1.050	1.250	0.041	0.049
A1	0.000	0.100	0.000	0.004
A2	1.050	1.150	0.041	0.045
b	0.300	0.500	0.012	0.020
c	0.100	0.200	0.004	0.008
D	2.820	3.020	0.111	0.119
E	1.500	1.700	0.059	0.067
E1	2.650	2.950	0.104	0.116
e	0.950 BSC		0.037 BSC	
e1	1.900 BSC		0.075 BSC	
L	0.300	0.600	0.012	0.024
θ	0°	8°	0°	8°

PACKAGE INFORMATION

TAPE AND REEL INFORMATION

REEL DIMENSIONS

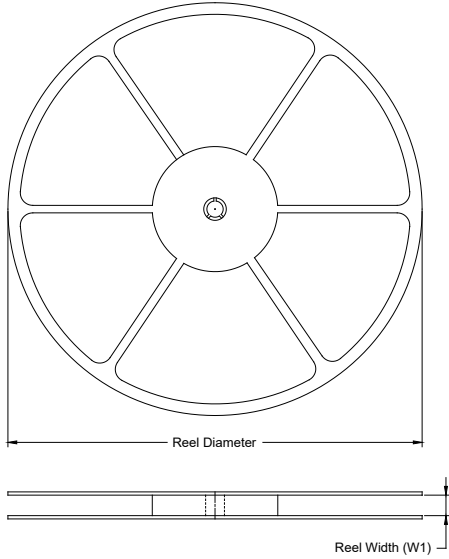

TAPE DIMENSIONS

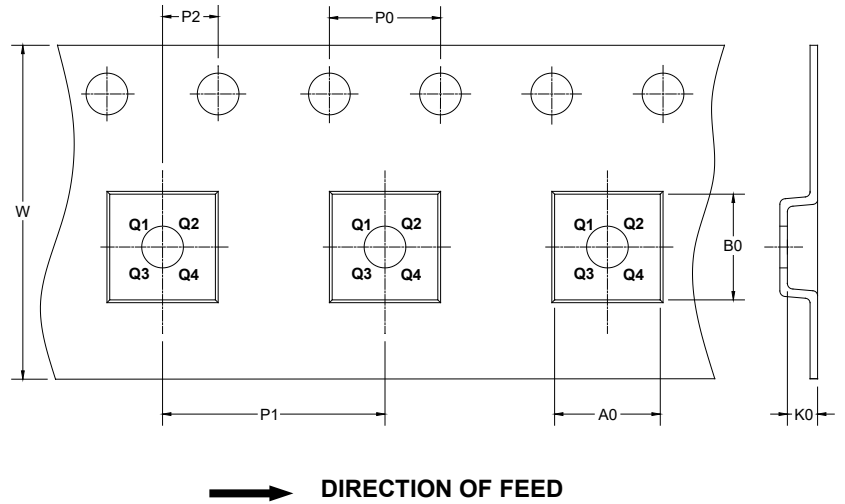

NOTE: The picture is only for reference. Please make the object as the standard.

KEY PARAMETER LIST OF TAPE AND REEL

Package Type	Reel Diameter	Reel Width W1 (mm)	A0 (mm)	B0 (mm)	K0 (mm)	P0 (mm)	P1 (mm)	P2 (mm)	W (mm)	Pin1 Quadrant
SOT-23-6	7"	9.5	3.17	3.23	1.37	4.0	4.0	2.0	8.0	Q3

000001

PACKAGE INFORMATION

CARTON BOX DIMENSIONS



NOTE: The picture is only for reference. Please make the object as the standard.

KEY PARAMETER LIST OF CARTON BOX

Reel Type	Length (mm)	Width (mm)	Height (mm)	Pizza/Carton
7" (Option)	368	227	224	8
7"	442	410	224	18

DD0002