

GENERAL DESCRIPTION

The SGM6610 is a high-efficient synchronous boost converter. The 2.7V to 12V operation input voltage is suitable for single-cell or two-cell Li-Ion batteries. This device is capable to provide 10A switch current and an output voltage range of 4.5V to 12.6V. The SGM6610 has two operation modes, the pulse width modulation (PWM) mode and pulse frequency modulation (PFM). The PWM mode is applied at moderate to heavy loads. The PFM mode is applied at light load to improve the efficiency. An adjustable switching frequency of 200kHz to 2.2MHz can be operated in the PWM mode. The protection features include output over-voltage protection at 13.2V, cycle-by-cycle over-current protection and thermal shutdown. The device also involves the functions of programmable soft-start and adjustable switch peak current limit.

The SGM6610 is available in a Green TQFN-4.5×3.5-20L package. It operates over an ambient temperature range of -40°C to +85°C.

FEATURES

- **2.7V to 12V Input Voltage Range**
- **4.5V to 12.6V Output Voltage Range**
- **10A Switch Current**
- **91% Peak Efficiency**
($V_{IN} = 3.3V$, $V_{OUT} = 9V$, and $I_{OUT} = 3A$)
- **0.5 μ A Current into VIN Pin in Shutdown**
- **200kHz to 2.2MHz Adjustable Switching Frequency**
- **Adjustable Switch Peak Current Limit**
- **Programmable Soft-Start**
- **PFM Mode at Light Load**
- **13.2V Over-Voltage Protection**
- **Cycle-by-Cycle Over-Current Protection**
- **Thermal Shutdown**
- **Available in a Green TQFN-4.5×3.5-20L Package**

APPLICATIONS

Portable POS
Bluetooth Speaker
E-Cigarette
Fast-Charging Power Bank

PACKAGE/ORDERING INFORMATION

MODEL	PACKAGE DESCRIPTION	SPECIFIED TEMPERATURE RANGE	ORDERING NUMBER	PACKAGE MARKING	PACKING OPTION
SGM6610	TQFN-4.5x3.5-20L	-40°C to +85°C	SGM6610YTQS20G/TR	SGM6610 YTQS20 XXXXX	Tape and Reel, 4000

MARKING INFORMATION

NOTE: XXXXX = Date Code and Vendor Code.

XXXXX

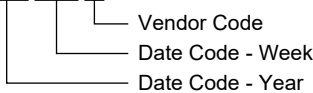

Green (RoHS & HSF): SG Micro Corp defines "Green" to mean Pb-Free (RoHS compatible) and free of halogen substances. If you have additional comments or questions, please contact your SGMICRO representative directly.

ABSOLUTE MAXIMUM RATINGS

- BOOT Voltage -0.3V to $V_{SW} + 6V$
- VIN, SW, VOUT Voltages -0.3V to 14.5V
- EN, VCC, FSW, SS, COMP Voltages -0.3V to 6V
- ILIM, FB Voltages -0.3V to 6V
- Junction Temperature +150°C
- Storage Temperature Range -65°C to +150°C
- Lead Temperature (Soldering, 10s) +260°C
- ESD Susceptibility
- HBM 2000V
- MM 400V
- CDM 1000V

RECOMMENDED OPERATING CONDITIONS

- Inductance, Effective Value, L 0.22µH to 4.7µH
- Input Capacitance, Effective Value, C_{IN} 10µF (MIN)
- Output Capacitance, Effective Value, C_{OUT} .. 6.8µF to 1000µF
- Input Voltage Range 2.7V to 12V
- Output Voltage Range 4.5V to 12.6V
- Operating Ambient Temperature Range -40°C to +85°C
- Operating Junction Temperature Range -40°C to +125°C

OVERSTRESS CAUTION

Stresses beyond those listed in Absolute Maximum Ratings may cause permanent damage to the device. Exposure to absolute maximum rating conditions for extended periods may affect reliability. Functional operation of the device at any conditions beyond those indicated in the Recommended Operating Conditions section is not implied.

ESD SENSITIVITY CAUTION

This integrated circuit can be damaged if ESD protections are not considered carefully. SGMICRO recommends that all integrated circuits be handled with appropriate precautions. Failure to observe proper handling and installation procedures can cause damage. ESD damage can range from subtle performance degradation to complete device failure. Precision integrated circuits may be more susceptible to damage because even small parametric changes could cause the device not to meet the published specifications.

DISCLAIMER

SG Micro Corp reserves the right to make any change in circuit design, or specifications without prior notice.

PIN CONFIGURATION

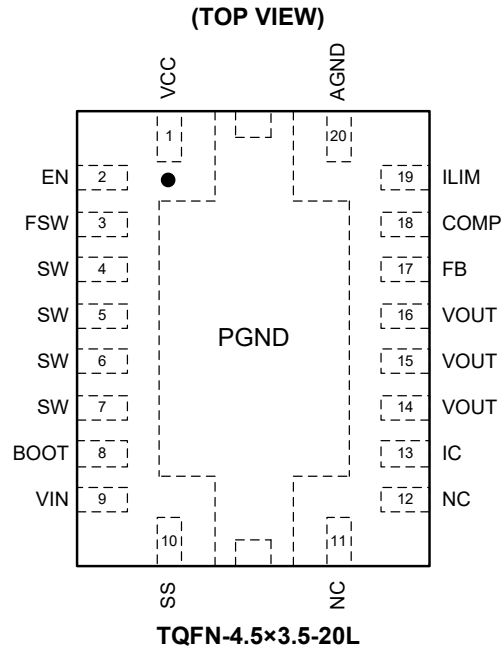

PIN DESCRIPTION

PIN	NAME	I/O	FUNCTION
1	VCC	O	Output of the Internal Regulator. The VCC pin connects a ceramic capacitor (> 1.0 μ F) to ground.
2	EN	I	Enable Logic Input. Logic high makes the circuit enabled, and logic low makes it disabled and the device enters shutdown mode.
3	FSW	I	Put a resistor between this pin and the AGND pin to program the switching frequency.
4, 5, 6, 7	SW	I	Switching Node Pin of the Converter. Connect to the drain of the internal low-side power MOSFET and source of the internal high-side power MOSFET.
8	BOOT	O	Power Supply for High-side MOSFET Gate Driver. Strongly recommend to apply a ceramic capacitor of 0.1 μ F between this pin and SW pin.
9	VIN	I	IC Power Supply Input.
10	SS	O	Soft-Start Programming Pin.
11, 12	NC	–	No Connection inside the Device. To achieve good thermal dissipation, connect the NC pins to ground plane on the PCB.
13	IC	I	Internal Connection. Leave it floating or connect to VCC.
14, 15, 16	VOUT	O	Boost Converter Output.
17	FB	I	Output Voltage Feedback. An external resistor divider programs the output voltage.
18	COMP	O	Output of the Internal Error Amplifier. Connect a loop compensation network between COMP and the AGND.
19	ILIM	O	Adjustable Switch Peak Current Limit. Connect an external resistor between this pin and the AGND.
20	AGND	–	Signal Ground of the IC.
Exposed Pad	PGND	–	Power Ground of the IC. Connect to the source of the low-side MOSFET.

NOTE: I = input, O = output.

ELECTRICAL CHARACTERISTICS

(Minimum and maximum values are at $V_{IN} = 2.7V$ to $5.5V$ and Full = $-40^{\circ}C$ to $+85^{\circ}C$. Typical values are at $V_{IN} = 3.6V$ and $T_A = +25^{\circ}C$. $L = 1.2\mu H$, $C_{OUT} = 47\mu F$, unless otherwise specified noted.)

PARAMETER	SYMBOL	CONDITIONS	TEMP	MIN	TYP	MAX	UNITS	
Power Supply								
Input Voltage Range	V_{IN}		Full	2.7		12	V	
VIN Under-Voltage Lockout Threshold	V_{IN_UVLO}	V_{IN} rising	$+25^{\circ}C$		2.5	2.65	V	
		V_{IN} falling	$+25^{\circ}C$		2.4			
VIN Under-Voltage Lockout Hysteresis	V_{IN_HYS}		$+25^{\circ}C$		100		mV	
VCC Under-Voltage Lockout Threshold	V_{CC_UVLO}	V_{CC} falling	$+25^{\circ}C$		2.1		V	
Operating Quiescent Current	VIN Pin	I_Q	$+25^{\circ}C$		IC enabled, $V_{EN} = 2V$, no load, $R_{ILIM} = 100k\Omega$, $V_{FB} = 1.23V$, $V_{OUT} = 12V$	0.22	0.4	μA
	VOUT Pin					80	130	
Shutdown Current into the VIN Pin	I_{SHDN}	IC disabled, $V_{EN} = 0V$, no load, no feedback resistor divider connected to the VOUT pin	$+25^{\circ}C$		0.5	1.2	μA	
VCC Regulation	V_{CC}	$I_{VCC} = 5mA$, $V_{IN} = 8V$	$+25^{\circ}C$		5		V	
EN Input								
EN High Threshold Voltage	V_{ENH}	$V_{CC} = 5V$	Full	1.3			V	
EN Low Threshold Voltage	V_{ENL}	$V_{CC} = 5V$	Full			0.4	V	
EN Internal Pull-Down Resistance	R_{EN}	$V_{CC} = 5V$	$+25^{\circ}C$		800		k Ω	
Output								
Output Voltage Range	V_{OUT}		Full	4.5		12.6	V	
Reference Voltage at the FB Pin	V_{REF}	PWM mode	Full	1.180	1.204	1.234	V	
		PFM mode	$+25^{\circ}C$		1.206			
FB Pin Leakage Current	I_{LKG_FB}	$V_{FB} = 1.2V$	$+25^{\circ}C$			0.1	μA	
Soft-Start Charging Current	I_{SS}		$+25^{\circ}C$		4		μA	
Error Amplifier								
COMP Pin Sink Current	I_{SINK}	$V_{FB} = V_{REF} + 100mV$, $V_{COMP} = 1.2V$	$+25^{\circ}C$		120		μA	
COMP Pin Source Current	I_{SOURCE}	$V_{FB} = V_{REF} - 100mV$, $V_{COMP} = 1.2V$	$+25^{\circ}C$		18		μA	
High Clamp Voltage at the COMP Pin	V_{CCLPH}	$V_{FB} = 1.1V$, $R_{ILIM} = 100k\Omega$	$+25^{\circ}C$		2		V	
Low Clamp Voltage at the COMP Pin	V_{CCLPL}	$V_{FB} = 1.3V$, $R_{ILIM} = 100k\Omega$	$+25^{\circ}C$		0.4		V	
Error Amplifier Transconductance	G_{EA}	$V_{COMP} = 1.2V$	$+25^{\circ}C$		150		$\mu A/V$	
Power Switch								
High-side MOSFET On-Resistance	$R_{DS(ON)}$	$V_{CC} = 5V$	$+25^{\circ}C$		13	16.5	m Ω	
Low-side MOSFET On-Resistance		$V_{CC} = 5V$	$+25^{\circ}C$		11	13.5	m Ω	
Current Limit								
Switch Peak Current Limit	I_{LIM}	$R_{ILIM} = 100k\Omega$, $V_{CC} = 5V$	$+25^{\circ}C$	9.3	11.3	13.4	A	
Reference Voltage at the ILIM Pin	V_{ILIM}		$+25^{\circ}C$		1.208		V	

ELECTRICAL CHARACTERISTICS (continued)

(Minimum and maximum values are at $V_{IN} = 2.7V$ to $5.5V$ and Full = $-40^{\circ}C$ to $+85^{\circ}C$. Typical values are at $V_{IN} = 3.6V$ and $T_A = +25^{\circ}C$. $L = 1.2\mu H$, $C_{OUT} = 47\mu F$, unless otherwise specified noted.)

PARAMETER	SYMBOL	CONDITIONS	TEMP	MIN	TYP	MAX	UNITS
Switching Frequency							
Switching Frequency	f_{SW}	$R_{FREQ} = 301k\Omega$, $V_{IN} = 3.6V$, $V_{OUT} = 12V$	$+25^{\circ}C$		500		kHz
Minimum On-Time	t_{ON_MIN}	$R_{FREQ} = 301k\Omega$, $V_{IN} = 3.6V$, $V_{OUT} = 12V$	$+25^{\circ}C$		120		ns
Protection							
Output Over-Voltage Protection Threshold	V_{OVP}	V_{OUT} rising	Full	12.83	13.2	13.55	V
Output Over-Voltage Protection Hysteresis	V_{OVP_HYS}	V_{OUT} falling below V_{OVP}	$+25^{\circ}C$		0.15		V
Thermal Shutdown							
Thermal Shutdown Threshold	T_{SD}	T_A rising			155		$^{\circ}C$
Thermal Shutdown Hysteresis	T_{SD_HYS}	T_A falling below T_{SD}			15		$^{\circ}C$

TYPICAL PERFORMANCE CHARACTERISTICS

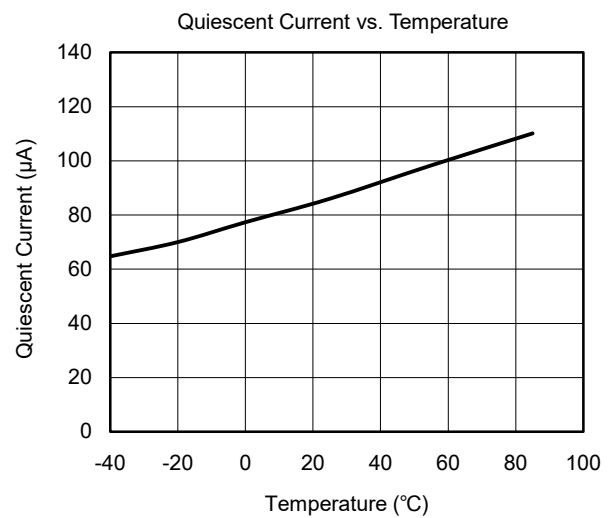
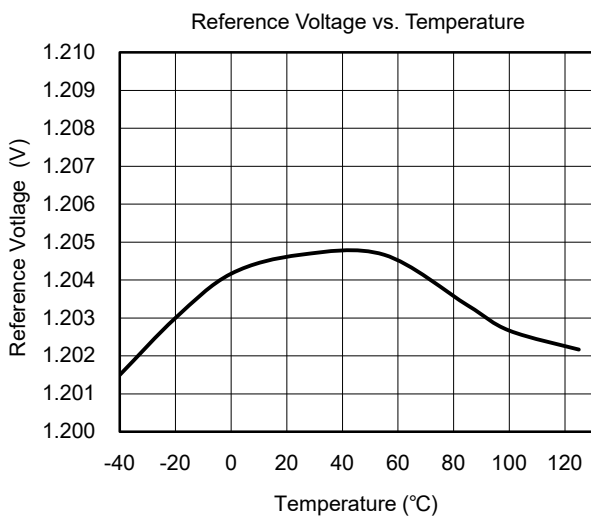
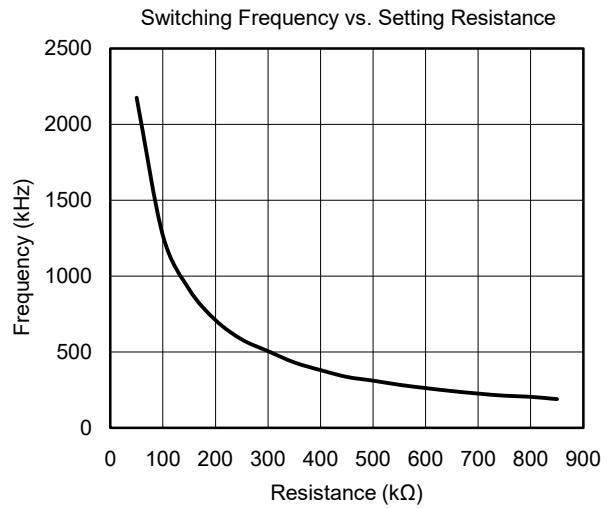
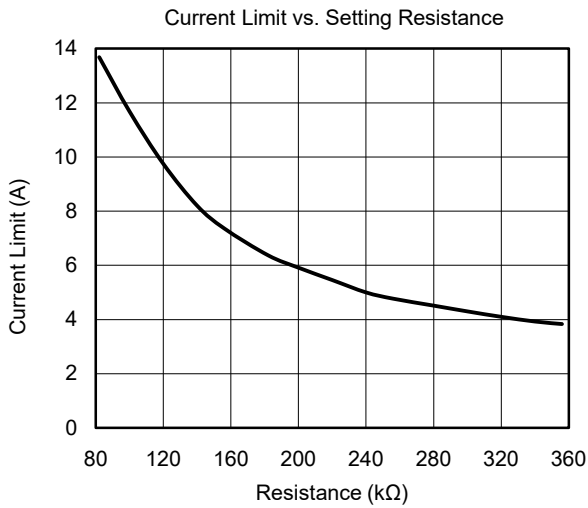
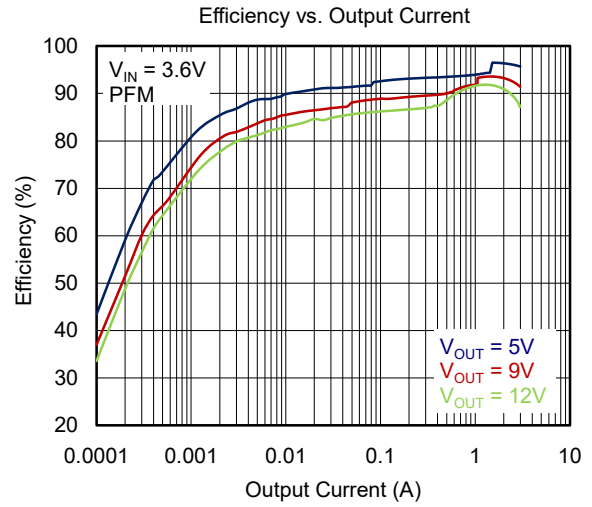
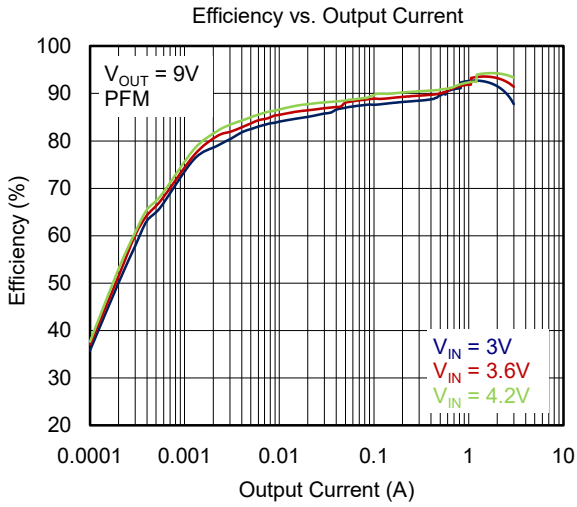

TYPICAL PERFORMANCE CHARACTERISTICS (continued)

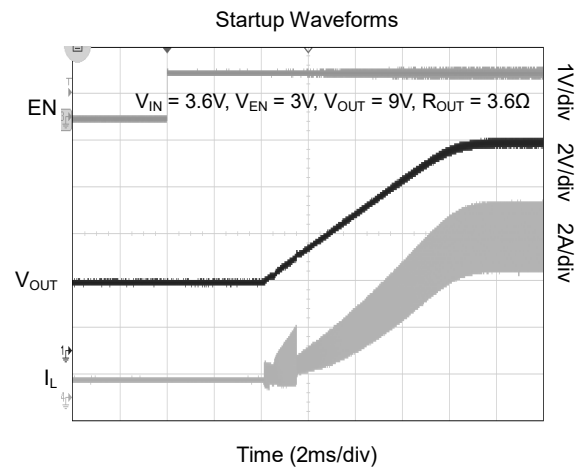
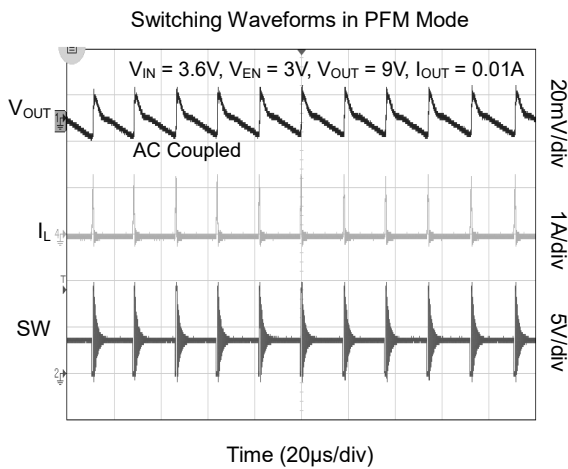
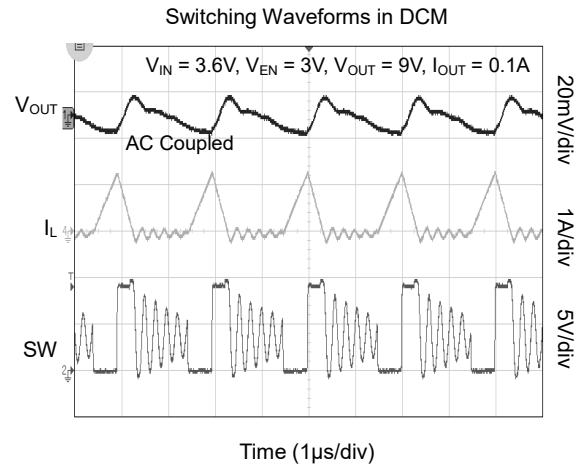
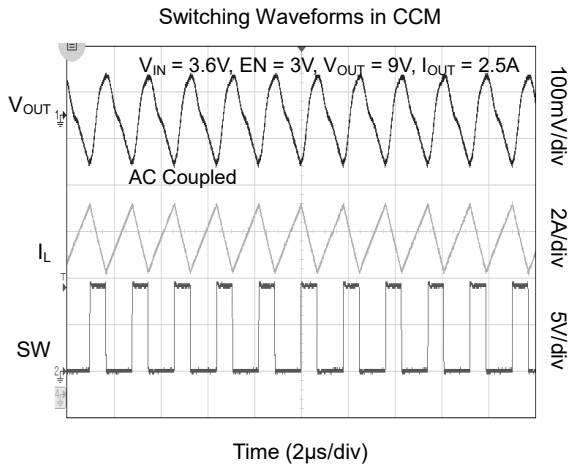
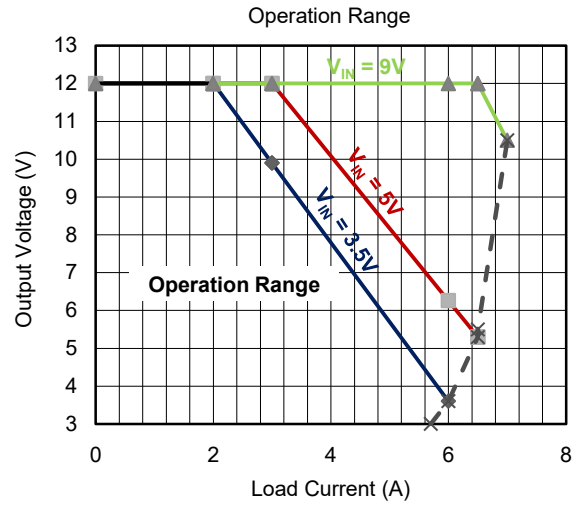
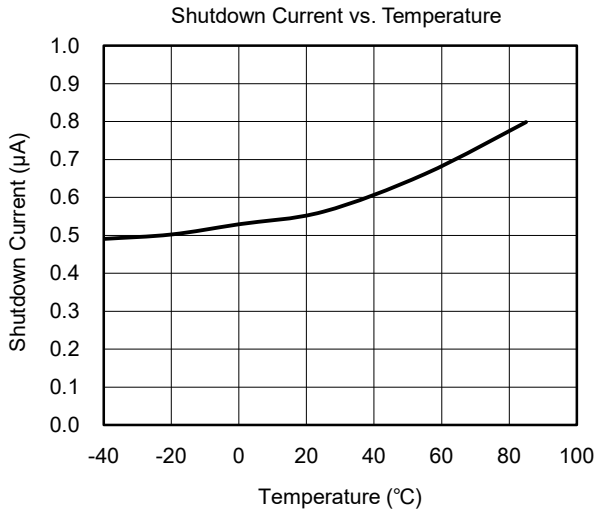

TYPICAL PERFORMANCE CHARACTERISTICS (continued)

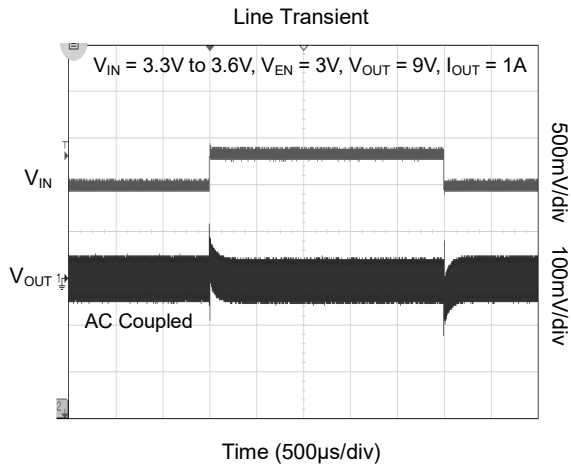
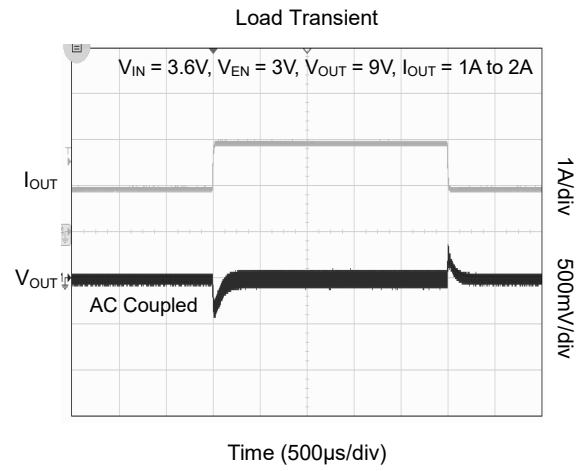
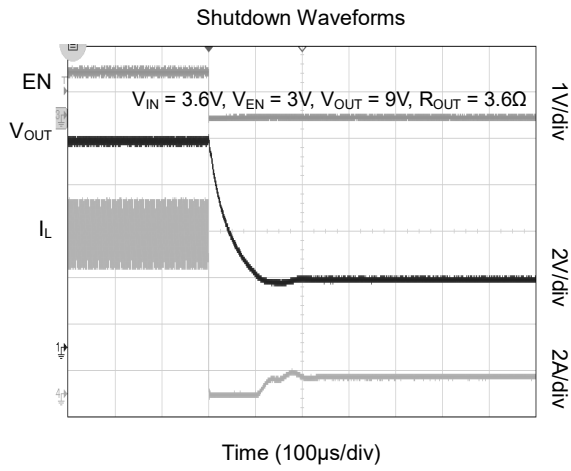

PCB LAYOUT

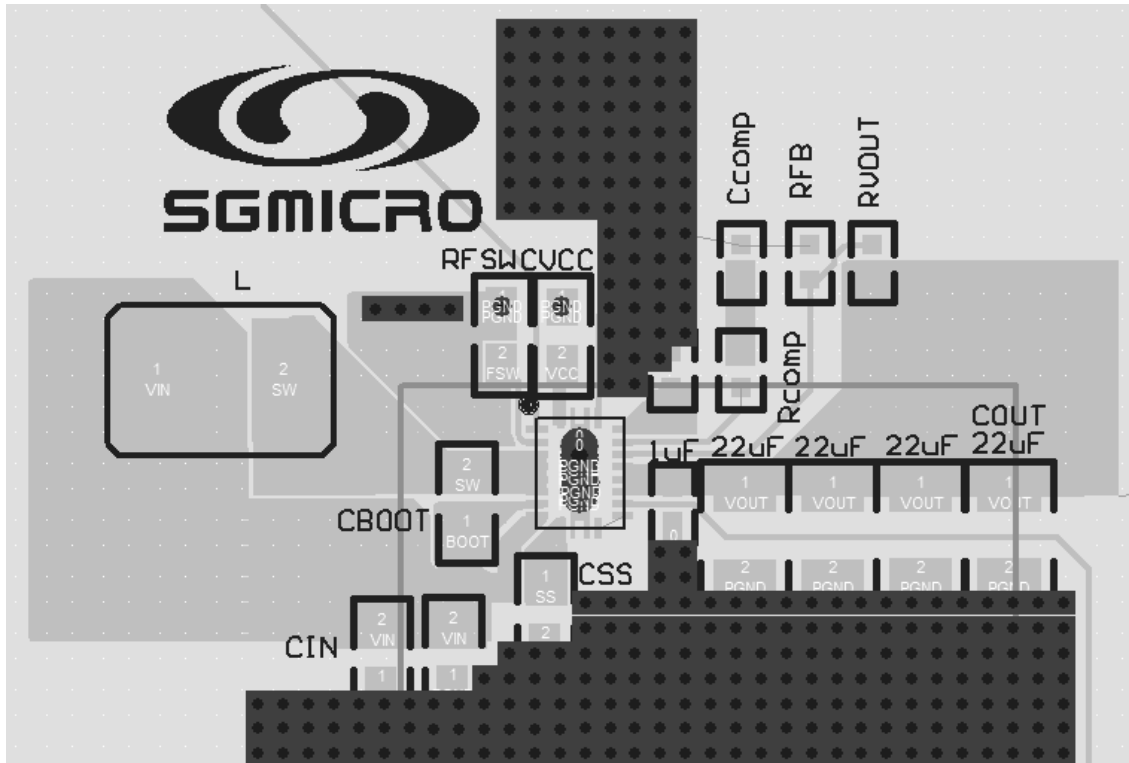

Figure 1. Top Layer

REVISION HISTORY

NOTE: Page numbers for previous revisions may differ from page numbers in the current version.

	Page
<hr/>	
DECEMBER 2021 – REV.A.2 to REV.A.3	
Updated the Typical Performance Characteristics section	6-8
<hr/>	
OCTOBER 2021 – REV.A.1 to REV.A.2	Page
Updated the Enable and Startup section.....	10
<hr/>	
SEPTEMBER 2018 – REV.A to REV.A.1	Page
Changed MODE pin to IC pin	All
<hr/>	
Changes from Original (NOVEMBER 2017) to REV.A	Page
Changed from product preview to production data.....	All
<hr/>	

PACKAGE OUTLINE DIMENSIONS

TQFN-4.5x3.5-20L

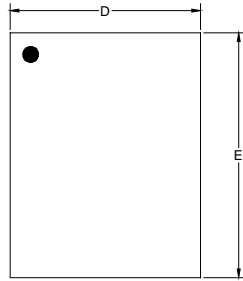

TOP VIEW

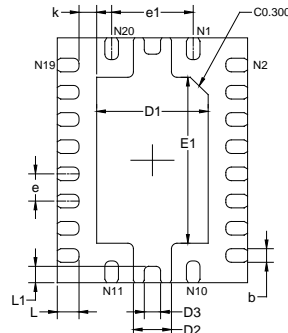

BOTTOM VIEW

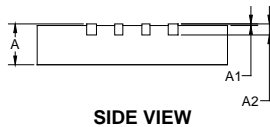

SIDE VIEW

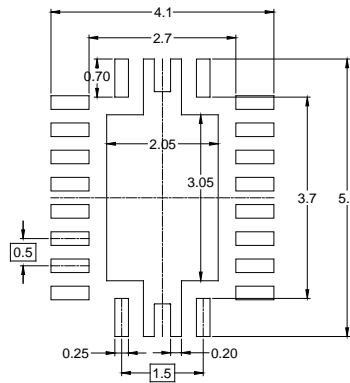

RECOMMENDED LAND PATTERN (Unit: mm)

Symbol	Dimensions In Millimeters		Dimensions In Inches	
	MIN	MAX	MIN	MAX
A	0.700	0.800	0.028	0.031
A1	0.000	0.050	0.000	0.002
A2	0.203 REF		0.008 REF	
D	3.400	3.600	0.134	0.142
D1	1.950	2.150	0.077	0.085
D2	0.650	0.850	0.026	0.033
D3	0.250	0.450	0.010	0.018
E	4.400	4.600	0.173	0.181
E1	2.950	3.150	0.116	0.124
k	0.325 REF		0.013 REF	
b	0.200	0.300	0.008	0.012
L	0.300	0.500	0.012	0.020
L1	0.224	0.376	0.009	0.015
e	0.500 BSC		0.020 BSC	
e1	1.500 BSC		0.060 BSC	

NOTE: This drawing is subject to change without notice.

PACKAGE INFORMATION

TAPE AND REEL INFORMATION

REEL DIMENSIONS



TAPE DIMENSIONS



NOTE: The picture is only for reference. Please make the object as the standard.

KEY PARAMETER LIST OF TAPE AND REEL

Package Type	Reel Diameter	Reel Width W1 (mm)	A0 (mm)	B0 (mm)	K0 (mm)	P0 (mm)	P1 (mm)	P2 (mm)	W (mm)	Pin1 Quadrant
TQFN-4.5×3.5-20L	13"	12.4	3.75	4.75	0.95	4.0	8.0	2.0	12.0	Q1

DD0001

PACKAGE INFORMATION

CARTON BOX DIMENSIONS



NOTE: The picture is only for reference. Please make the object as the standard.

KEY PARAMETER LIST OF CARTON BOX

Reel Type	Length (mm)	Width (mm)	Height (mm)	Pizza/Carton
13"	386	280	370	5

DD0002