

GENERAL DESCRIPTION

The SGM6022 is a high-efficient Buck switching voltage regulator, supporting up to 600mA output current and fixed output voltage. This device is capable to provide an input voltage supply range of 2.5V to 5.5V. The 6MHz fixed frequency operation allows the use of a 470nH output inductor and a 4.7µF output capacitor.

The SGM6022 operates in power-save mode under moderate and light load conditions through pulse frequency modulation (PFM). The 22µA typical quiescent current and the power-save mode can further improve the system efficiency which can reach a maximum of 90%. The SGM6022 also has excellent load transient response capability. Its output could be programmed to four different voltages, as well as two different on/off delay times, making it ideal for designing primary supplies. The SGM6022 also includes the features of internal soft-start, input under-voltage lockout, thermal shutdown and overload protection.

The SGM6022 is available in a Green TDFN-2×2-6L package. It operates over an ambient temperature range of -40°C to +125°C.

FEATURES

- 2.5V to 5.5V Input Voltage Range
- 600mA Output Current Capability
- 22µA Typical Quiescent Current
- 6MHz Fixed Frequency Operation
- Excellent Efficiency and Load Transient Response
- Precision Preset Voltage Selectable from 4 Preset Voltages in 1.02V ~ 3V Range
- Programmable Output Voltage
- Low Ripple Light-Load PFM Mode
- Internal Soft-Start
- Input Under-Voltage Lockout (UVLO)
- Overload Protection
- Thermal Shutdown
- Output Discharge
- Available in a Green TDFN-2×2-6L Package
- -40°C to +125°C Operating Temperature Range

APPLICATIONS

Digital Cameras
4G, WiFi, WiMAsX, and WiBro Data Cards
Tablet Computers
Netbooks, Ultra-Mobile PCs

TYPICAL APPLICATION

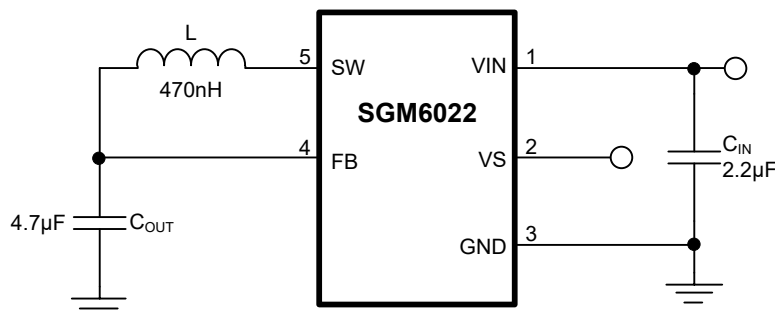

Figure 1. Typical Application Circuit

PACKAGE/ORDERING INFORMATION

MODEL	PACKAGE DESCRIPTION	SPECIFIED TEMPERATURE RANGE	ORDERING NUMBER	PACKAGE MARKING	PACKING OPTION
SGM6022-1	TDFN-2x2-6L	-40°C to +125°C	SGM6022-1XTDI6G/TR	GDA XXXX	Tape and Reel, 3000
SGM6022-2	TDFN-2x2-6L	-40°C to +125°C	SGM6022-2XTDI6G/TR	GDB XXXX	Tape and Reel, 3000
SGM6022-3	TDFN-2x2-6L	-40°C to +125°C	SGM6022-3XTDI6G/TR	GH8 XXXX	Tape and Reel, 3000
SGM6022-4	TDFN-2x2-6L	-40°C to +125°C	SGM6022-4XTDI6G/TR	GDC XXXX	Tape and Reel, 3000

MARKING INFORMATION

NOTE: XXXX = Date Code.

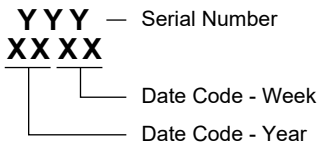

SELECTABLE MODEL

MODEL	V _{OUT} (V)	V1 (V)	V2 (V)	V3 (V)
SGM6022-1	1.25	1.2	1.1	1.02
SGM6022-2	3	2.8	2.4	2
SGM6022-3	2.8	2.5	2.2	1.8
SGM6022-4	1.8	1.6	1.4	1.2

Green (RoHS & HSF): SG Micro Corp defines "Green" to mean Pb-Free (RoHS compatible) and free of halogen substances. If you have additional comments or questions, please contact your SGMICRO representative directly.

ABSOLUTE MAXIMUM RATINGS

Input Voltage.....	-0.3V to 6.5V
Voltage on SW and VS	-0.3V to V _{IN} + 0.3V ⁽³⁾
Junction Temperature.....	+150°C
Storage Temperature Range	-65°C to +150°C
Lead Temperature (Soldering, 10s).....	+260°C
ESD Susceptibility	
HBM.....	4000V
MM.....	400V

NOTE: 3. Lesser of 6.5V or V_{IN} + 0.3V.

RECOMMENDED OPERATING CONDITIONS

Inductor, L.....	470nH
Input Capacitor, C _{IN}	2.2µF
Output Capacitor, C _{OUT}	4.7µF
Supply Voltage Range	2.5V to 5.5V
Operating Temperature Range	-40°C to +125°C

OVERSTRESS CAUTION

Stresses beyond those listed in Absolute Maximum Ratings may cause permanent damage to the device. Exposure to absolute maximum rating conditions for extended periods may affect reliability. Functional operation of the device at any conditions beyond those indicated in the Recommended Operating Conditions section is not implied.

ESD SENSITIVITY CAUTION

This integrated circuit can be damaged if ESD protections are not considered carefully. SGMICRO recommends that all integrated circuits be handled with appropriate precautions. Failure to observe proper handling and installation procedures can cause damage. ESD damage can range from subtle performance degradation to complete device failure. Precision integrated circuits may be more susceptible to damage because even small parametric changes could cause the device not to meet the published specifications.

DISCLAIMER

SG Micro Corp reserves the right to make any change in circuit design, or specifications without prior notice.

PIN CONFIGURATION

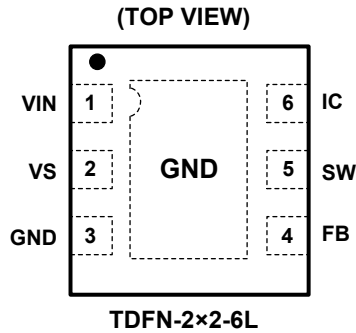

PIN DESCRIPTION

PIN	NAME	FUNCTION
1	VIN	Input Voltage. Connect to input power source.
2	VS	Voltage Selection and Programming Input. Pull this pin up for period $> (t_{BLANK} + t_{SS})$ to start from shutdown state to output a default voltage or a programmable voltage, and pull this pin down for period $(> t_{STOP})$ to select the default voltage or shut down its operation. This pin internally ties to a bias that is slightly higher than logic low threshold unless in shutdown state, which keeps it stay as logic high even when the external control IO is in Hi-Z status.
3	GND	Ground. All signals are referenced to this pin.
4	FB	Feedback/ V_{OUT} . Connect to output voltage.
5	SW	Switching Node. Connect to output inductor.
6	IC	For Internal Connection.
Exposed Pad	GND	Connect to GND.

ELECTRICAL CHARACTERISTICS

(Minimum and maximum values are at $V_{IN} = V_{VS} = 2.5V$ to $5.5V$, Full = $-40^{\circ}C$ to $+125^{\circ}C$; typical values are at $V_{IN} = V_{VS} = 3.6V$, $T_A = +25^{\circ}C$, unless otherwise noted.)

PARAMETER	SYMBOL	CONDITIONS	TEMP	MIN	TYP	MAX	UNITS
Power Supplies							
Input Voltage Range	V_{IN}		Full	2.5		5.5	V
Quiescent Current	I_Q	No Load, Not Switching	Full		22	40	μA
Shutdown Supply Current	I_{SD}	$VS = GND$	$+25^{\circ}C$		0.45	1	μA
Under-Voltage Lockout Threshold	V_{UVLO}	Rising V_{IN}	$+25^{\circ}C$		2.15	2.42	V
Under-Voltage Lockout Hysteresis	V_{UVHYS}		$+25^{\circ}C$		150		mV
VS Logic Input							
Enable High-Level Input Voltage	V_{IH}		Full	1.0			V
Enable Low-Level Input Voltage	V_{IL}		Full			0.15	V
Switching							
Switching Frequency	f_{SW}	$V_{IN} = 3.6V$, $T_A = +25^{\circ}C$	$+25^{\circ}C$	5.5	6	6.5	MHz
Output							
Output Voltage	V_{OUT}	$V_{IN} = 2.5V$ to $5.5V$	Full	1.201	1.250	1.277	V
			Full	1.150	1.200	1.226	
			Full	1.056	1.100	1.126	
			Full	0.976	1.000	1.047	
Soft-Start	t_{SS}	From VS Rising Edge	$+25^{\circ}C$		200		μs
Output Driver							
PMOS On Resistance	$R_{DS(ON)}$	$V_{IN} = V_{GS} = 3.6V$	$+25^{\circ}C$		350		$m\Omega$
NMOS On Resistance		$V_{IN} = V_{GS} = 3.6V$	$+25^{\circ}C$		250		$m\Omega$
PMOS Peak Current Limit	$I_{LIM(OL)}$		$+25^{\circ}C$	1630	1900	2130	mA
Output Discharge Resistance	R_{DIS}	$VS = GND$	$+25^{\circ}C$		230		Ω
Thermal Shutdown	T_{TSD}				160		$^{\circ}C$
Thermal Shutdown Hysteresis	T_{HYS}				15		$^{\circ}C$
Digital VS Interface							
Power-On Blanking Time	t_{BLANK}		$+25^{\circ}C$		40		ms
VS Change Stop Time	t_{STOP}		$+25^{\circ}C$	2	2.5	3	ms
Shutdown Delay	t_{OFF}		$+25^{\circ}C$	90	110	130	ms
t_{OFF} Hold On Time	$t_{OFF-HOLD}$		$+25^{\circ}C$	35	45	55	ms
Effective Pulse Time	t_{PULSE}		$+25^{\circ}C$	0.15		2.8	ms

TYPICAL PERFORMANCE CHARACTERISTICS

$V_{IN} = V_{VS} = 3.6V$, $T_A = +25^\circ C$, $V_{OUT} = 1.2V$, unless otherwise noted.

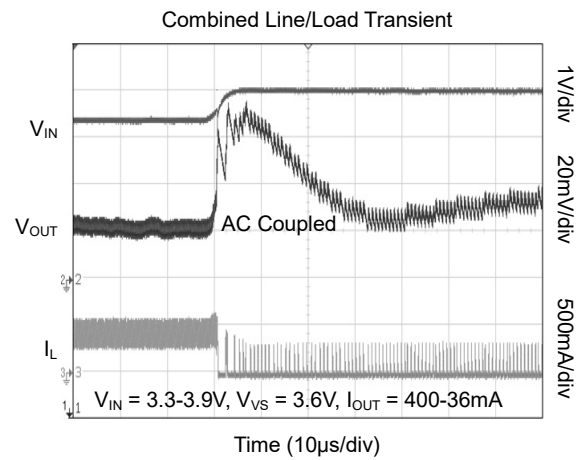
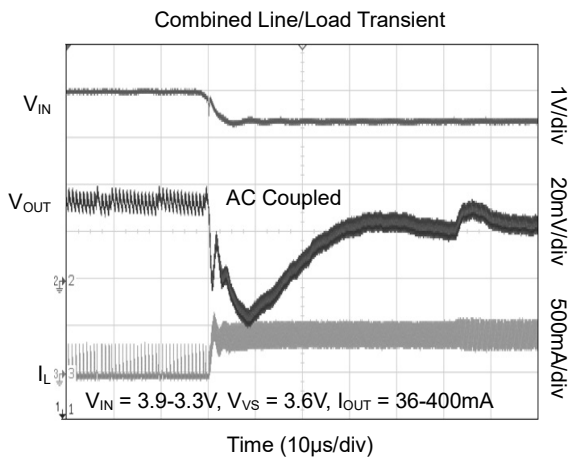
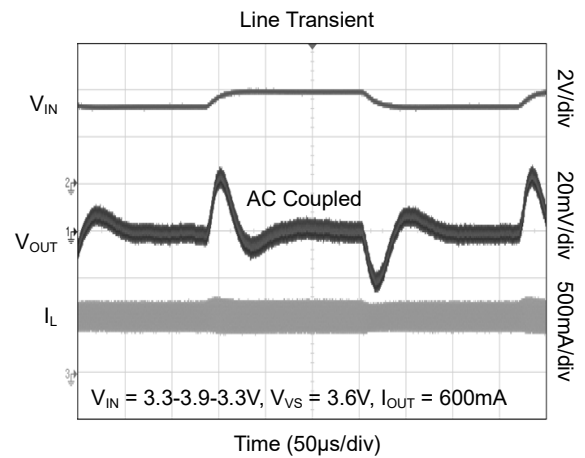
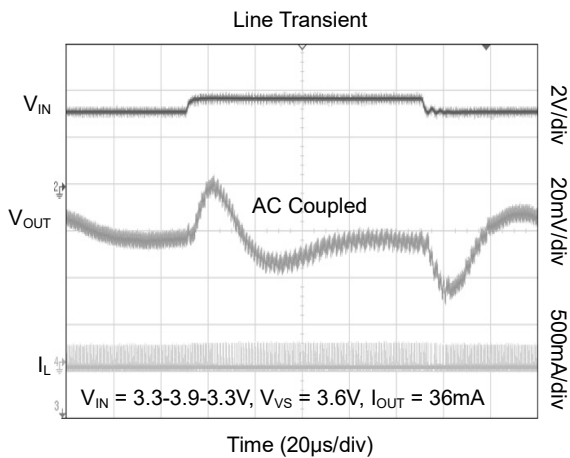
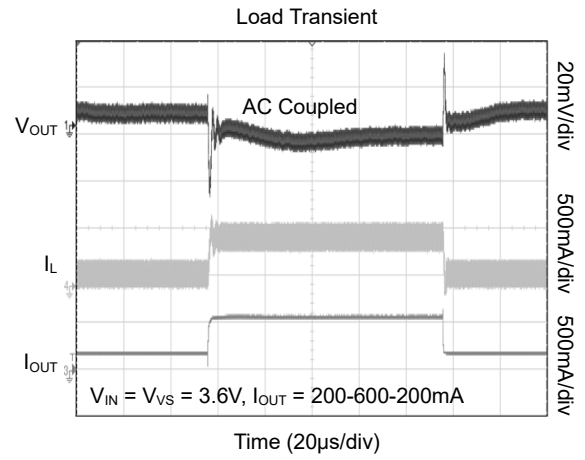
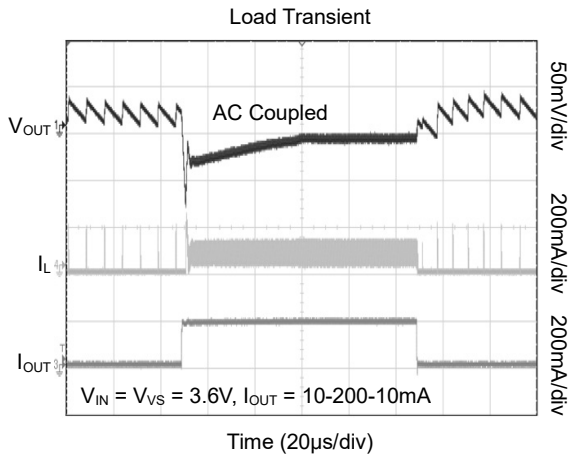

TYPICAL PERFORMANCE CHARACTERISTICS (continued)

$V_{IN} = V_{VS} = 3.6V$, $T_A = +25^{\circ}C$, $V_{OUT} = 1.2V$, unless otherwise noted.

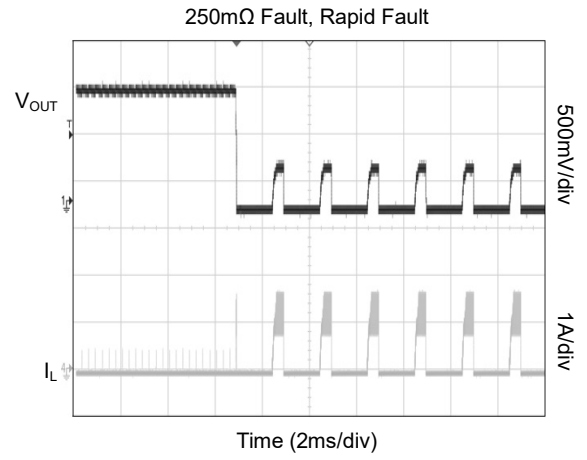
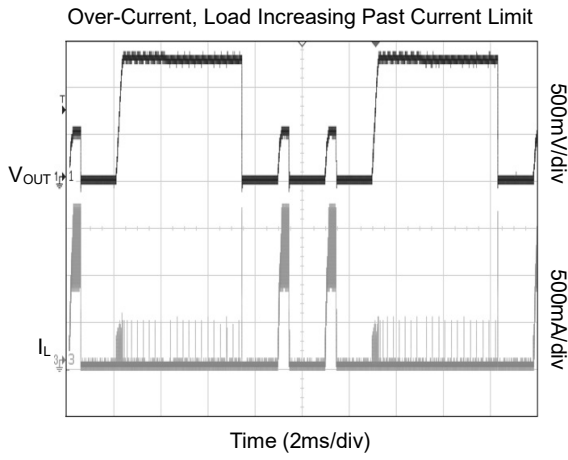

TYPICAL PERFORMANCE CHARACTERISTICS (continued)

$V_{IN} = V_{VS} = 3.6V$, $T_A = +25^\circ C$, $V_{OUT} = 1.2V$, unless otherwise noted.

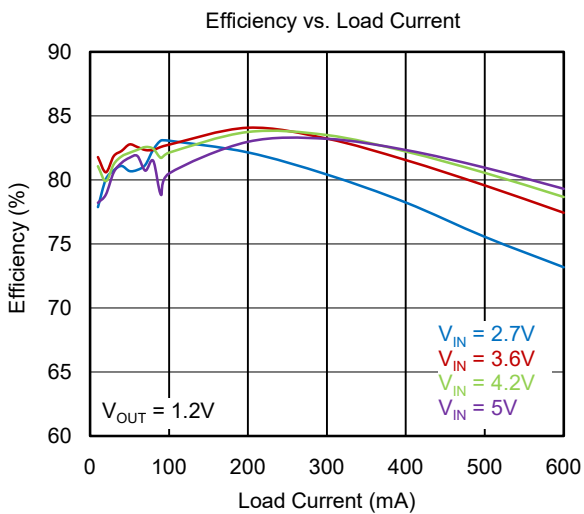
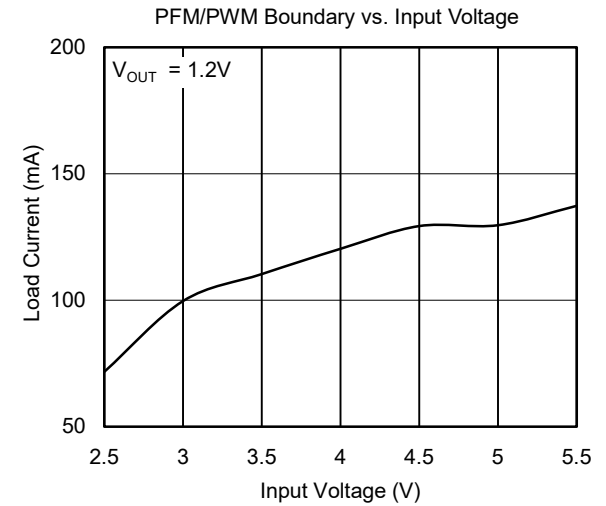
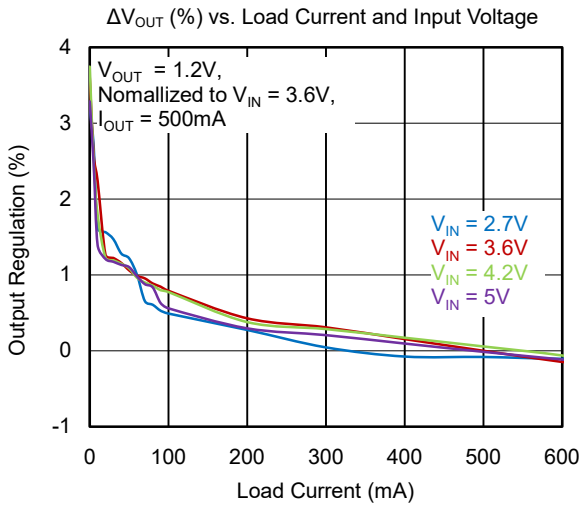
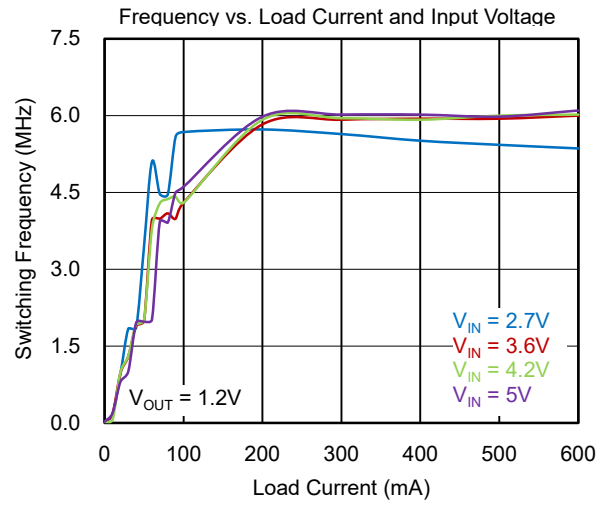
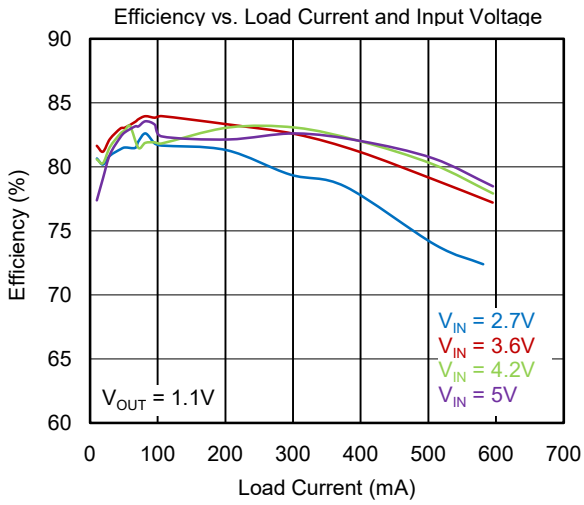

OPERATION DESCRIPTION

The SGM6022 is a synchronous Buck converter capable of delivering 600mA load to the output from an input supply range from 2.5V to 5.5V. The SGM6022 integrates a synchronous rectifier to improve the conversion efficiency up to 90% peak, while PFM mode light load efficiency reaches over 80% at 1mA load.

The device operates with 6MHz switching frequency at PWM mode which significantly reduces the external components size. The device only needs a 470nH inductor and 4.7 μ F as the output capacitor.

Control Scheme

The SGM6022 adopts the COT architecture to regulate the output voltage while maintaining excellent load transient response. The device's internal frequency loop keeps the switching frequency constant at 6MHz throughout the input voltage range and load current. The device allows the use of low ESR ceramic capacitor to maintain output voltage regulation.

At light load, the SGM6022 automatically operates in PFM mode to achieve high light load efficiency. The device can seamlessly transit to PFM, DCM or CCM based on the load current.

Soft-Start

Toggling the EN pin above the 1.5V rising threshold, the device starts switching with an internal soft-start time. During start-up, the internal reference voltage is slowly ramped up to the 0.8V reference voltage to prevent any output voltage overshoot and reduce the

inrush current drawn from the input.

The current limit protection is active during soft-start, the device might not start up properly if heavy load is applied during start-up.

Current Limit, Fault Shutdown and Restart

Output short-to-ground or output over-current will cause the peak inductor current flowing through the high-side switch to reach the current limit. If the current limit is triggered, the device stops switching, turning off the high-side FET to prevent the inductor current from continuing to rise. During the over-current event, the regulator shuts down for about 1.3ms, and the soft-start circuit attempts to restart for 200 μ s. If the over-current event remains, this pattern repeats, and the device automatically resumes operation if over-current condition is removed.

Effective Pulse at VS Pin

A pulse with width less than t_{PULSE} is treated as an effective pulse. Consecutive pulses will be counted if delay between adjacent pulses is within the t_{STOP} . Please refer to Figure 2 for a graphical explanation.

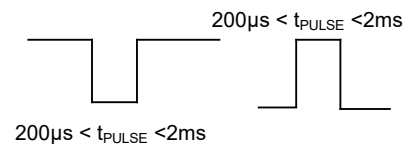

Figure 2. Effective Pulse at VS Pin

OPERATION DESCRIPTION (continued)

VS Pin Interface Functions

In order to enable the IC from shutdown mode, two conditions must be met:

1. VIN voltage is higher than UVLO threshold.
2. VS pin is floating or VS pin stays logic high for at least $t_{BLANK} + t_{SS}$ time.

After that, the pulses at VS pin become effective and can be used to shut down the IC or program the output voltage. The following are the three cases that the VS pin affects the regulator:

1. 1 pulse followed by VS pin being low for longer than t_{OFF} will shut down the regulator.

During the $t_{OFF-HOLD}$ time after shutdown, the pulses applied to VS Pin are ignored.

To restart the regulator, the VS pin must be pulled high for at least t_{SS} time.

2. 2~5 pulses followed by VS pin being high for longer than t_{OFF} will set the output voltage to the default, V1, V2 and V3 respectively.

3. 2 or more pulses followed by VS pin being low for longer than t_{OFF} will set the output voltage to the default value.

Other pulse patterns will have no effects on the IC.

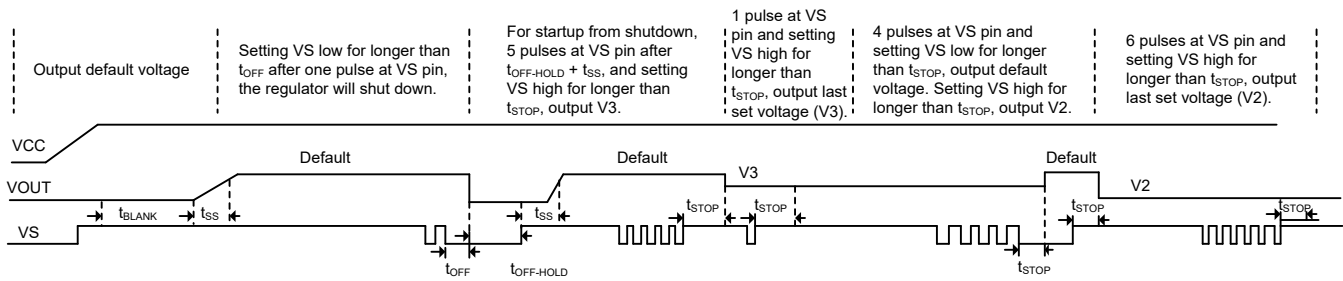

Figure 3. Program Output Voltage via VS Pin

Under-Voltage Lockout (UVLO)

The SGM6022 implements input voltage UVLO to stop device operation when the input voltage drops below the UVLO threshold. The device cannot restart again until the input voltage raises higher than the additional 150mV (TYP) hysteresis.

Thermal Shutdown (TSD)

A thermal shutdown function is implemented to prevent damage caused by excessive heat and power dissipation. Once a temperature of typically +160°C is exceeded, the device is shut down. The device is released from shutdown automatically when the junction temperature decreases by +15°C.

APPLICATION INFORMATION

Selecting the Inductor

The selected inductor should have enough saturation current rating to meet the maximum load current. In addition, the selected inductor value affects the peak current, PWM to PFM transition point and efficiency. Use Equation below to calculate the inductor ripple current:

$$\Delta I \approx \frac{V_{OUT}}{V_{IN}} \cdot \left(\frac{V_{IN} - V_{OUT}}{L \cdot f_{SW}} \right) \quad (1)$$

The maximum load current, $I_{MAX(LOAD)}$ can be calculated using Equation below:

$$I_{MAX(LOAD)} = I_{LIM(PK)} - \left(\frac{\Delta I}{2} \right) \quad (2)$$

When the inductor's valley current crosses zero, the device transits from PFM to PWM operation. Use Equation below to calculate the DC current when the inductor current reaches zero:

$$I_{DCM} = \frac{\Delta I}{2} \quad (3)$$

470nH is recommended for SGM6022. For application's duty cycle higher than 60%, 1μH inductor is recommended. In addition, the recommended maximum operation duty cycle for SGM6022 is 75%. The selected inductor should have at least 80% of the inductance at $I_{LIM(PK)}$.

Inductor's DCR and inductance affect the conversion efficiency. Inductor with lower inductance generally has lower DCR which improves the efficiency, however, the RMS current is increased due to increased peak to peak ripple current ΔI . Higher ΔI increases the inductor core loss which reduces the efficiency. Use Equation below to calculate the inductor RMS current:

$$I_{RMS} = \sqrt{I_{OUT(DC)}^2 + \frac{\Delta I^2}{12}} \quad (4)$$

Higher inductance results in lower RMS current, however, transient response is degraded. For the same family of inductors, higher inductance parts result in higher DCR and lower saturation current.

Table 1 summarizes the performance effects of inductance higher or lower than the recommended 0.47μH inductor.

Table 1. Effects of Changes in Inductor Value (from 470nH Recommended Value)

INDUCTOR VALUE	$I_{MAX(LOAD)}$	ΔV_{OUT}	TRANSIENT RESPONSE
Increase	Increase	Decrease	Degraded
Decrease	Decrease	Increase	Improved

Output Capacitor

A 4.7μF 0402 ceramic output capacitor is recommended for SGM6022. Larger size as 0603 results in higher effective capacitance under the same DC de-rating, which improves transient response and output ripple.

Use Equation below to calculate the output voltage ripple:

$$\Delta V_{OUT} = \Delta I_L \left[\frac{f_{SW} \cdot C_{OUT} \cdot ESR^2}{2 \cdot D \cdot (1-D)} + \frac{1}{8 \cdot f_{SW} \cdot C_{OUT}} \right] \quad (5)$$

Input Capacitor

A 2.2μF ceramic input capacitor is recommended to place as close as possible between the VIN pin and GND to minimize the parasitic inductance. For the applications where the SGM6022 is located far away from the input source, a 47μF or higher capacitance capacitor is recommended to damp the wiring harness's inductance.

APPLICATION INFORMATION (continued)

Table 2. Recommended Passive Components and their Variation Due to DC Bias

COMPONENT	DESCRIPTION	VENDOR	MIN	TYP	MAX
L	470nH, 2012, 90mΩ, 1.1A	Murata LQM21PNR47MC0 Murata LQM21PNR54MG0 Hitachi Metals HLSI 201210R47		470nH	
L	1μH, 2012, 0.1Ω, 1.5A	Murata LQM21PN1R0MGH		1μH	
L	1μH, 2012, 0.067Ω, 3.4A	Sunlord WPG201210UF1R0MT		1μH	
L	0.47μH, 2012, 0.033Ω, 5.15A	Sunlord WPG201210UFR47MT		0.47μH	
C _{IN}	2.2μF, 6.3V, X5R, 0402	Murata or Equivalent GRM155R60J225ME15 GRM188R60J225KE19D	1.0μF	2.2μF	
C _{OUT}	4.7μF, X5R, 0402	Murata or Equivalent GRM155R60G475M GRM155R60E475ME760	1.6μF	4.7μF	

PCB Layout Guidelines

In addition to component selection, layout is a critical step to ensure the performance of any switch mode power supplies. Poor layout could result in system instability, EMI failure, and device damage. Thus, place the inductor, input and output capacitors as close to the

IC as possible, and use wide and short traces for current carrying traces to minimize PCB inductance. For Buck converter, the input capacitor's current loop from VIN pin back to the GND pin of the device should be as small as possible.

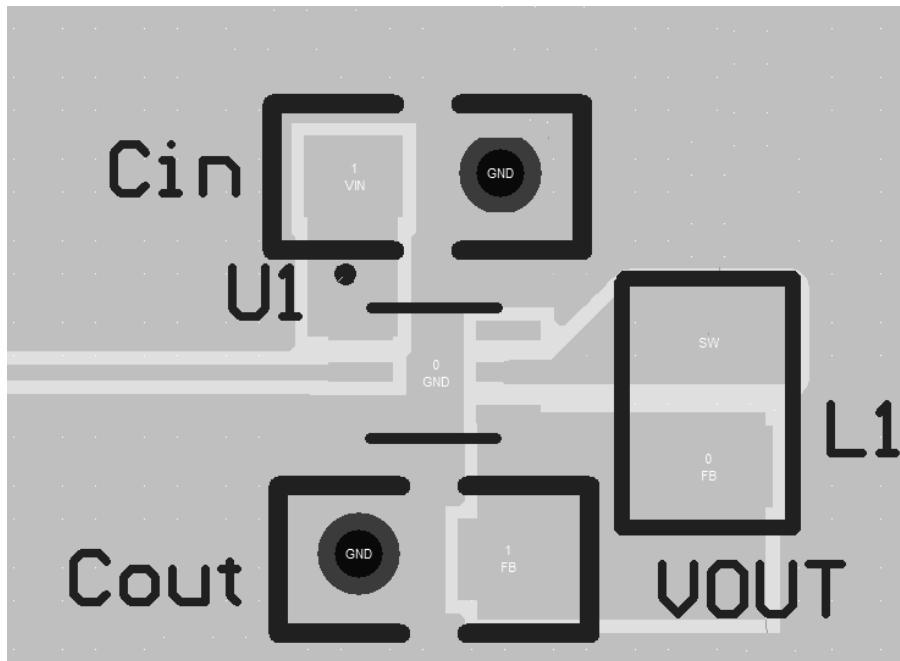

Figure 4. PCB Layout Guidance

REVISION HISTORY

NOTE: Page numbers for previous revisions may differ from page numbers in the current version.

JUNE 2022 – REV.A.1 to REV.A.2	Page
Updated the Detailed Description and Application Information sections	8, 10, 11

JULY 2020 – REV.A to REV.A.1	Page
Updated the Operating Temperature Range	1, 2, 4

Changes from Original (APRIL 2017) to REV.A	
Changed from product preview to production data.....	All

PACKAGE OUTLINE DIMENSIONS

TDFN-2x2-6L

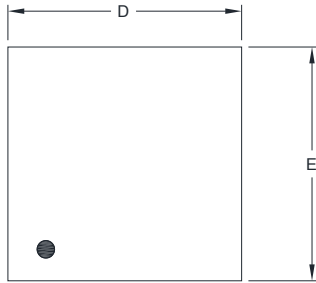

TOP VIEW

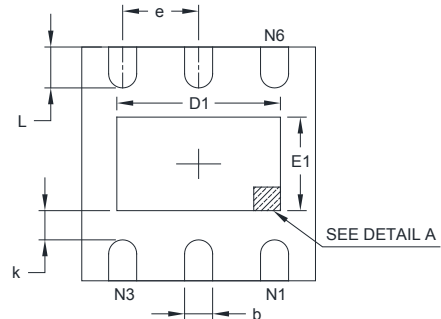

BOTTOM VIEW

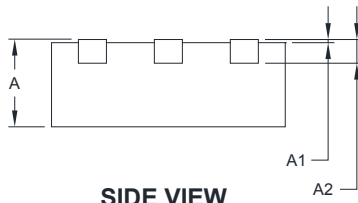

SIDE VIEW

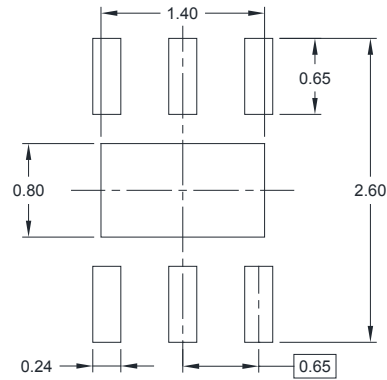

RECOMMENDED LAND PATTERN (Unit: mm)

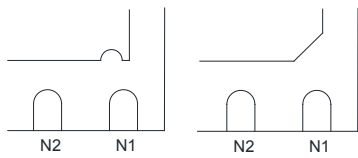

DETAIL A

Pin #1 ID and Tie Bar Mark Options

NOTE: The configuration of the Pin #1 identifier is optional, but must be located within the zone indicated.

Symbol	Dimensions In Millimeters		Dimensions In Inches	
	MIN	MAX	MIN	MAX
A	0.700	0.800	0.028	0.031
A1	0.000	0.050	0.000	0.002
A2	0.203 REF		0.008 REF	
D	1.900	2.100	0.075	0.083
D1	1.100	1.450	0.043	0.057
E	1.900	2.100	0.075	0.083
E1	0.600	0.850	0.024	0.034
k	0.200 MIN		0.008 MIN	
b	0.180	0.300	0.007	0.012
e	0.650 TYP		0.026 TYP	
L	0.250	0.450	0.010	0.018

TAPE AND REEL INFORMATION

REEL DIMENSIONS



TAPE DIMENSIONS



NOTE: The picture is only for reference. Please make the object as the standard.

KEY PARAMETER LIST OF TAPE AND REEL

Package Type	Reel Diameter	Reel Width W1 (mm)	A0 (mm)	B0 (mm)	K0 (mm)	P0 (mm)	P1 (mm)	P2 (mm)	W (mm)	Pin1 Quadrant
TDFN-2x2-6L	7"	9.5	2.30	2.30	1.10	4.0	4.0	2.0	8.0	Q1

DD0001

PACKAGE INFORMATION

CARTON BOX DIMENSIONS



NOTE: The picture is only for reference. Please make the object as the standard.

KEY PARAMETER LIST OF CARTON BOX

Reel Type	Length (mm)	Width (mm)	Height (mm)	Pizza/Carton
7" (Option)	368	227	224	8
7"	442	410	224	18

DD0002