

GENERAL DESCRIPTION

The SGM6021 family is a 200mA, 1.4MHz synchronous Buck DC/DC converter with 400nA ultra-low quiescent current, which is ideal for powering ultra-low power applications with special needs.

The SGM6021 operation voltage range is from 1.8V to 5.5V, allowing the use of a regulated 5V input. The output regulator levels are programmed through VS pin and can be programmed for 4 different voltages, making it ideal for designing device with limited power budget calculation.

The SGM6021 delivers an output current of 200mA with a peak inductor current of 430mA. Besides, the SGM6021 series has the under-voltage lockout (UVLO) function. It is disabled when the voltage on VIN reaches the UVLO condition. The SGM6021's under-voltage lockout level is continuously monitored. Only inductor, C_{IN} and C_{OUT} capacitors are needed as external components to make a Buck DC/DC converter solution.

The SGM6021 is available in a Green UTDFN-1.5x2-6L package.

TYPICAL APPLICATION

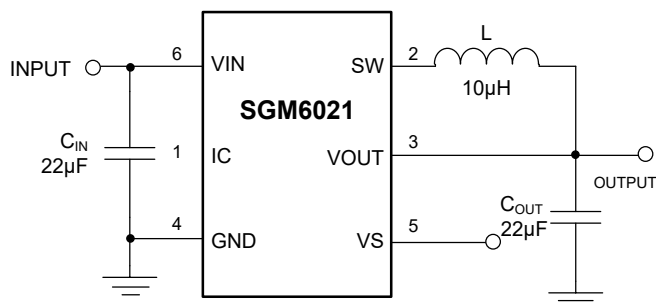

Figure 1. Typical Application Circuit

FEATURES

- **Input Voltage Range: 1.8V to 5.5V**
- **Output Voltage Programmable in Operation**
- **High Efficiency at Low Output Currents:**
Up to 90% with I_{OUT} = 0.1mA
- **Ultra-Low Power Buck Converter**
- **200mA (MAX) Output Current**
- **400nA (TYP) Quiescent Current**
- **100% Duty Cycle (Pass Mode)**
- **-40°C to +85°C Operating Temperature Range**
- **Available in a Green UTDFN-1.5x2-6L Package**

APPLICATIONS

Energy Harvest Devices
 Ultra-Low Power Applications
 Low-Power Wireless Monitoring
 Backup Power Supply Circuits
 2-Cell and 3-Cell Alkaline-Powered Systems
 Portable Game Consoles
 Wearable Devices
 Thermal Electric Generator Harvesting
 Wireless Sensor Networks
 Smart Building Controls
 Environmental Monitoring

SELECTABLE MODEL

MODEL	I _{OUT} (mA)	V _{OUT} (V)	V1 (V)	V2 (V)	V3 (V)
SGM6021-1	200	1.25	1.20	1.10	1.02
SGM6021-2	200	3.3	3.0	2.7	2.4
SGM6021-3	200	3.0	2.5	2.0	1.8
SGM6021-4	200	2.4	1.8	1.5	1.3

PACKAGE/ORDERING INFORMATION

MODEL	PACKAGE DESCRIPTION	SPECIFIED TEMPERATURE RANGE	ORDERING NUMBER	PACKAGE MARKING	PACKING OPTION
SGM6021-1	UTDFN-1.5×2-6L	-40°C to +85°C	SGM6021-1YUDT6G/TR	G90 XXX	Tape and Reel, 3000
SGM6021-2	UTDFN-1.5×2-6L	-40°C to +85°C	SGM6021-2YUDT6G/TR	GFD XXX	Tape and Reel, 3000
SGM6021-3	UTDFN-1.5×2-6L	-40°C to +85°C	SGM6021-3YUDT6G/TR	GFE XXX	Tape and Reel, 3000
SGM6021-4	UTDFN-1.5×2-6L	-40°C to +85°C	SGM6021-4YUDT6G/TR	GFF XXX	Tape and Reel, 3000

MARKING INFORMATION

NOTE: XXX = Date Code.

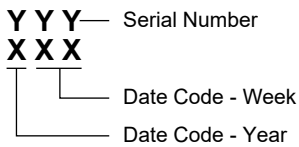

Green (RoHS & HSF): SG Micro Corp defines "Green" to mean Pb-Free (RoHS compatible) and free of halogen substances. If you have additional comments or questions, please contact your SGMICRO representative directly.

ABSOLUTE MAXIMUM RATINGS

- Input Voltage Range on VIN, VS, VOUT, SW -0.3V to 6V
- Peak Currents VIN, VOUT 510mA
- Junction Temperature +150°C
- Storage Temperature Range -65°C to +150°C
- Lead Temperature (Soldering, 10s) +260°C
- ESD Susceptibility
- HBM 7000V
- MM 400V
- CDM 1000V

RECOMMENDED OPERATING CONDITIONS

- Input Voltage Range 1.8V to 5.5V
- Input Capacitance, CIN 22µF (MIN)
- Output Capacitance, COUT 10µF (MIN), 22µF (TYP)
- Inductance, L 10µH (MIN)
- Operating Junction Temperature Range -40°C to +125°C
- Operating Ambient Temperature Range -40°C to +85°C

OVERSTRESS CAUTION

Stresses beyond those listed in Absolute Maximum Ratings may cause permanent damage to the device. Exposure to absolute maximum rating conditions for extended periods may affect reliability. Functional operation of the device at any conditions beyond those indicated in the Recommended Operating Conditions section is not implied.

ESD SENSITIVITY CAUTION

This integrated circuit can be damaged if ESD protections are not considered carefully. SGMICRO recommends that all integrated circuits be handled with appropriate precautions. Failure to observe proper handling and installation procedures can cause damage. ESD damage can range from subtle performance degradation to complete device failure. Precision integrated circuits may be more susceptible to damage because even small parametric changes could cause the device not to meet the published specifications.

DISCLAIMER

SG Micro Corp reserves the right to make any change in circuit design, or specifications without prior notice.

PIN CONFIGURATION

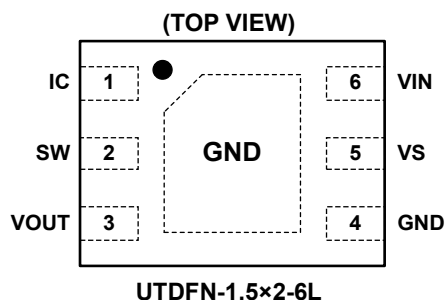

PIN DESCRIPTION

PIN	NAME	FUNCTION
1	IC	For Internal Connection.
2	SW	Switching Node. Connect to output inductor.
3	VOUT	Buck Regulator Output.
4	GND	Ground. Power and IC ground. All signals are referenced to this pin.
5	VS	Programming Regulator Output Voltage Input. Pull this pin up for period $> (t_{BLANK} + t_{SS})$ to start from shutdown state to output a default voltage or a programmable voltage, and pull this pin down for period $> t_{STOP}$ to select the default voltage or shut down its operation. This pin internally ties to a bias that is slightly higher than logic low threshold unless in shutdown state, which keeps it stay as logic high even when the external control I_O is in Hi-Z status.
6	VIN	Input Voltage. Connect to input power source.
Exposed Pad	GND	Connect to GND.

ELECTRICAL CHARACTERISTICS(V_{IN} = 3.6V, V_{OUT} = 1.25V, typical values are at T_A = +25°C. Full = -40°C to +85°C, unless otherwise noted.)

PARAMETER	SYMBOL	CONDITIONS	TEMP	MIN	TYP	MAX	UNITS
QUIESCENT CURRENT							
Buck Enabled State	I _Q	V _{IN} = 1.8V, no load, no switching	+25°C		400	700	nA
OUTPUT							
Output Accuracy			+25°C	-2		2	%
			Full	-3		3	
Output Line Regulation		V _{IN} = 1.8V to 5.5V, I _{OUT} = 100μA	+25°C		0.3		%/V
Output Load Regulation		I _{OUT} = 100μA to 200mA	+25°C		0.002		%/mA
Output Ripple		I _{OUT} = 1mA	+25°C		15		mV _{PP}
POWER SWITCH							
High-Side Switch ON Resistance	R _{DS(ON)}		+25°C		510	620	mΩ
Low-Side Switch ON Resistance			+25°C		530	690	
Cycle-by-Cycle Current Limit	I _{LIM}		+25°C	355	430	510	mA
Maximum Switching Frequency	f _{SW}		+25°C		1.4		MHz
INPUT							
Input Under Voltage Protection	V _{IN_UVLO}	V _{IN} falling	+25°C	1.19	1.3		V
VS							
VS Leakage Current	I _{VSH}	V _{VS} = 5.5V	+25°C		0.1	1	μA
Voltage for VS High Setting	V _{IH}		Full	1			V
Voltage for VS Low Setting	V _{IL}		Full			0.25	
Power-On Blanking Time	t _{BLANK}		+25°C		66		ms
VS Change Stop Time	t _{STOP}		+25°C	8	11	14	ms
Shutdown Delay	t _{OFF}		+25°C	99	135	170	ms
t _{OFF} Hold On Time	t _{OFF-HOLD}		+25°C	38	53	66	ms
Effective Pulse Time	t _{PULSE}		+25°C	1.5		2.5	ms
Soft Start Time	t _{SS}		+25°C		26		ms
THERMAL SHUTDOWN							
Thermal Shutdown	T _{TSD}				160		°C
Thermal Shutdown Hysteresis	T _{HYS}				20		°C

TYPICAL PERFORMANCE CHARACTERISTICS

T_A = +25°C, unless otherwise noted.

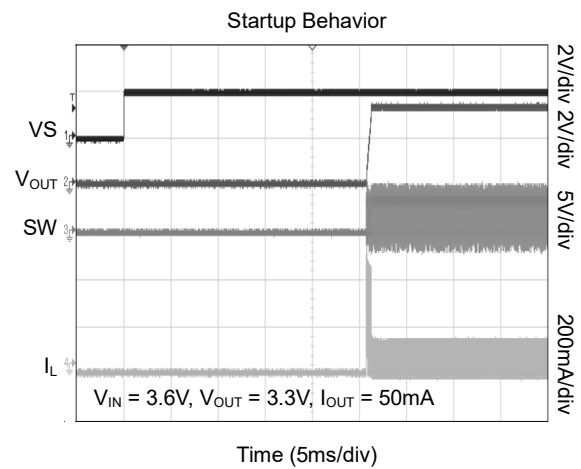
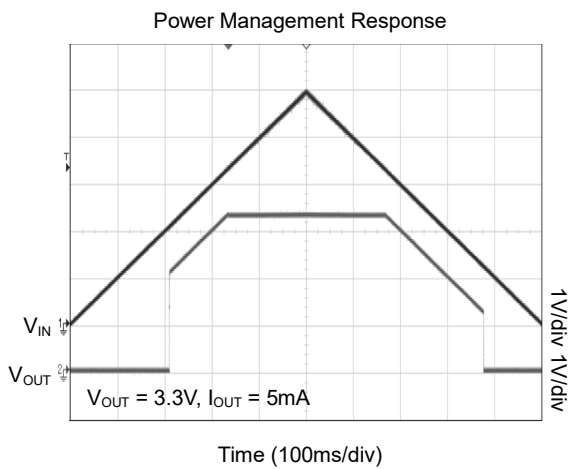
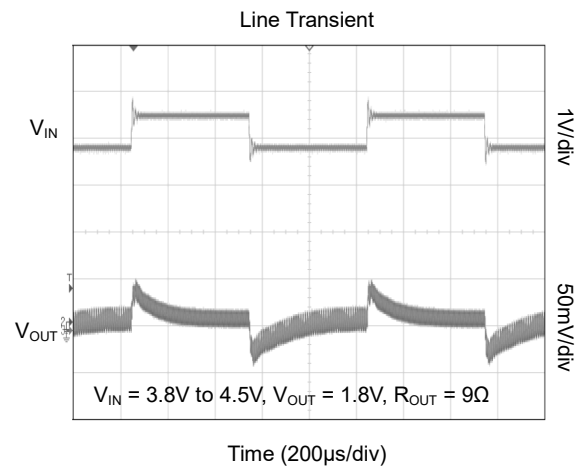
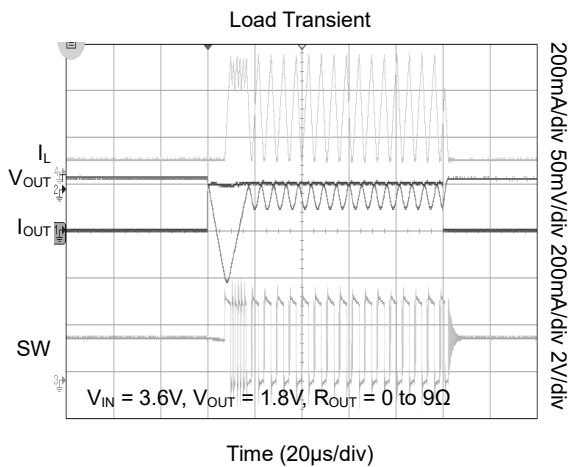
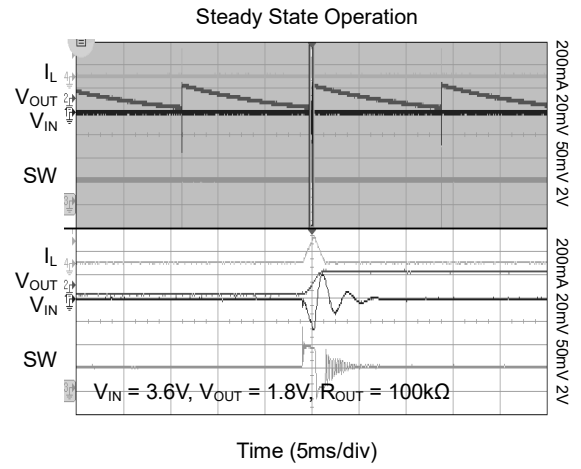
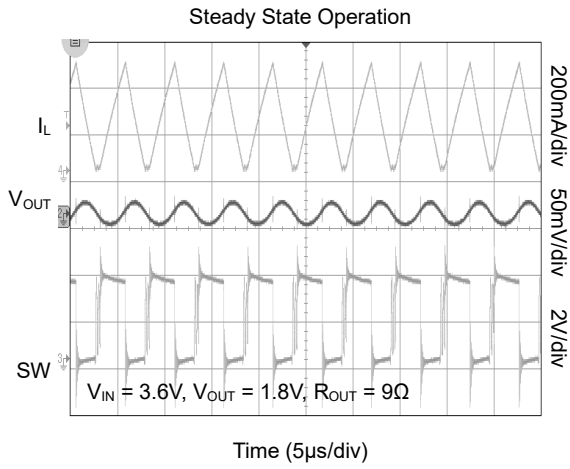

TYPICAL PERFORMANCE CHARACTERISTICS (continued)

T_A = +25°C, unless otherwise noted.

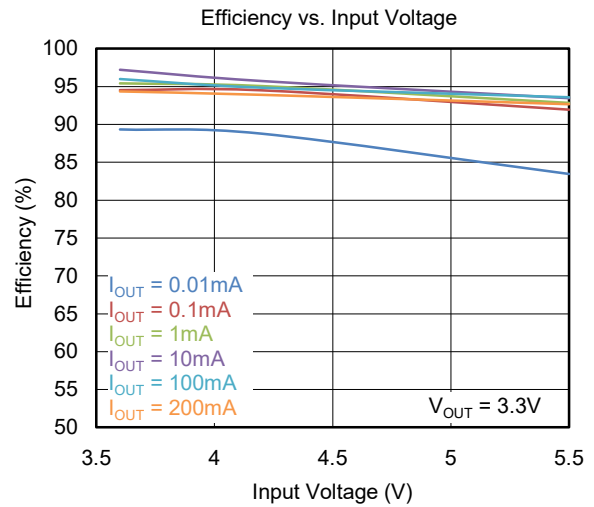
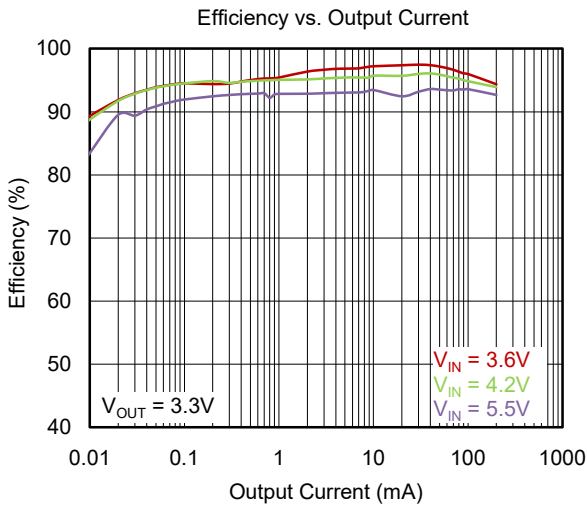
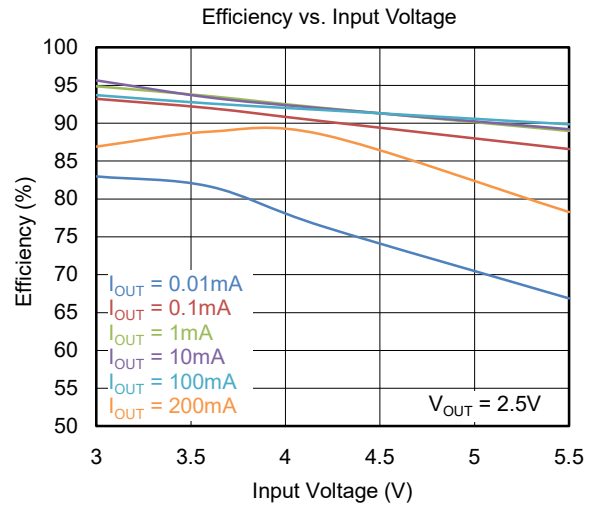
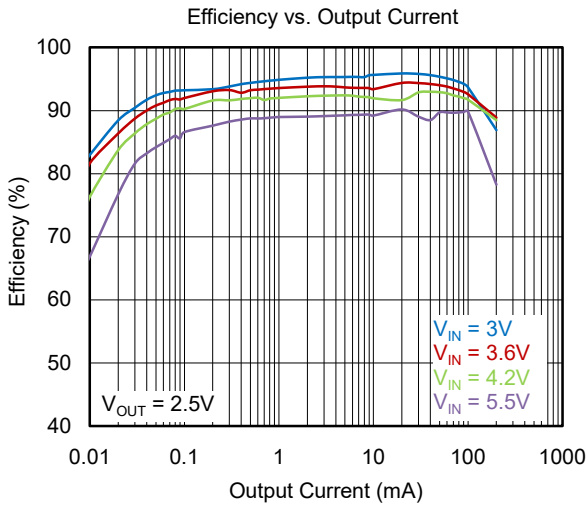
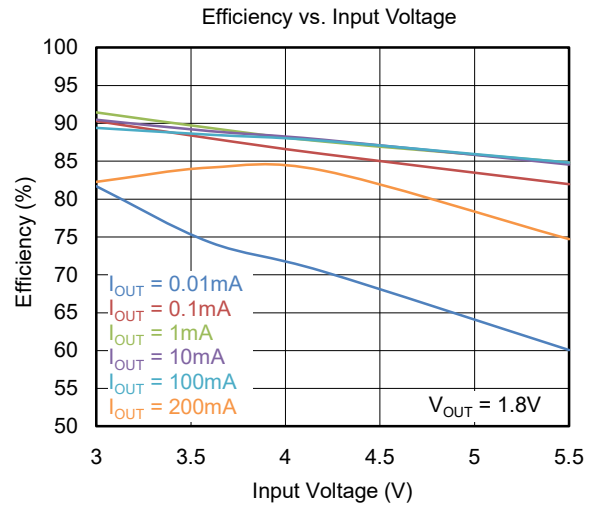
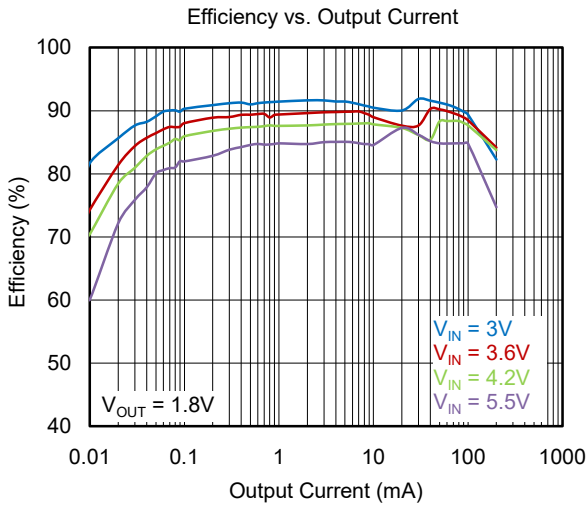

TYPICAL PERFORMANCE CHARACTERISTICS (continued)

T_A = +25°C, unless otherwise noted.

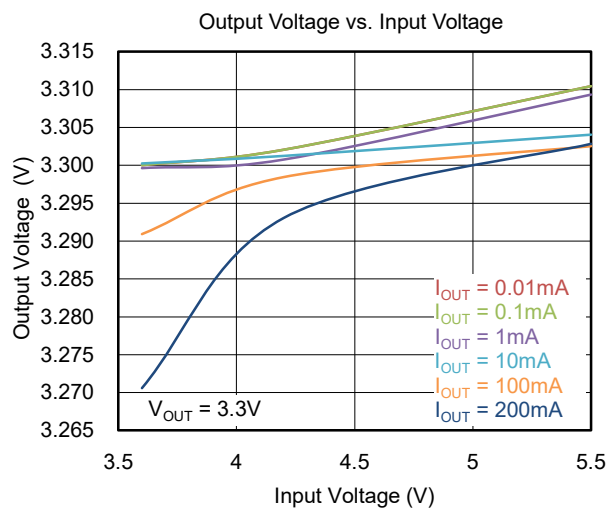
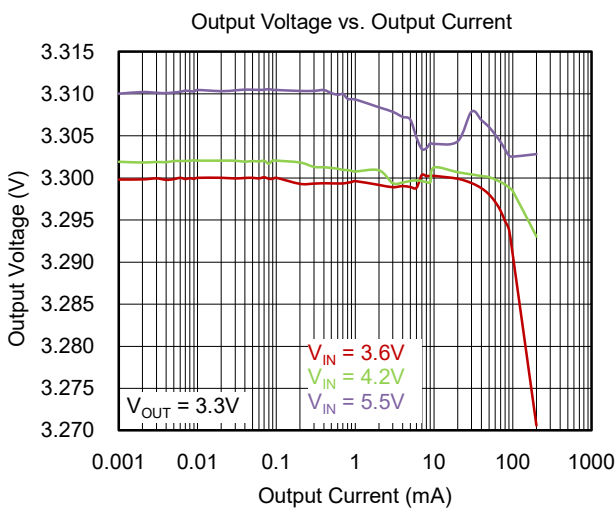
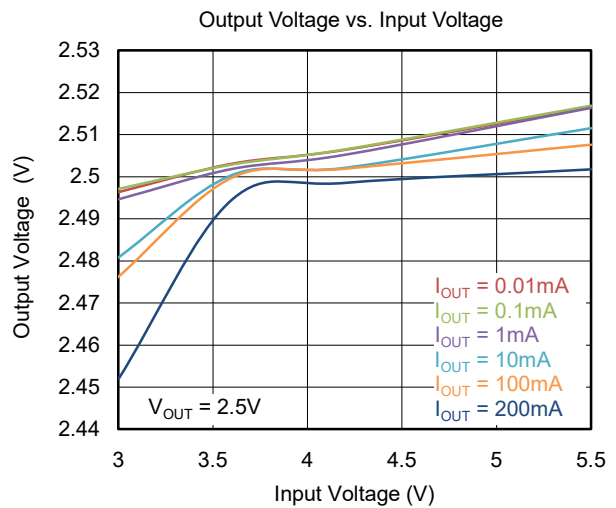
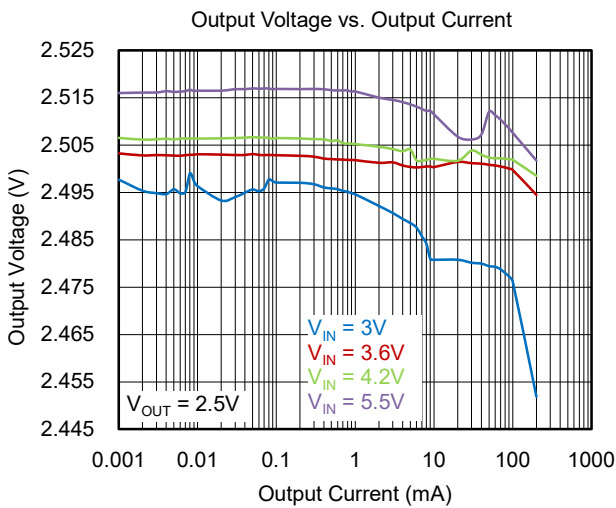
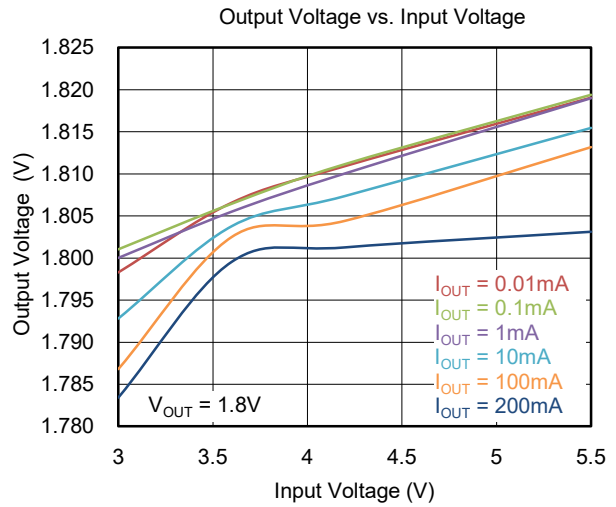
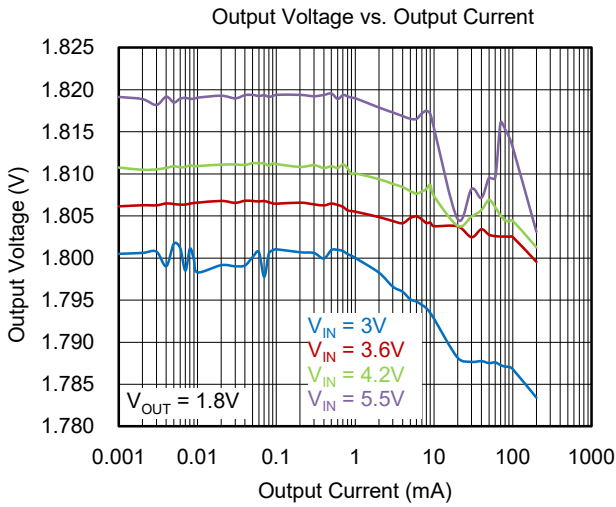

TYPICAL PERFORMANCE CHARACTERISTICS (continued)

T_A = +25°C, unless otherwise noted.

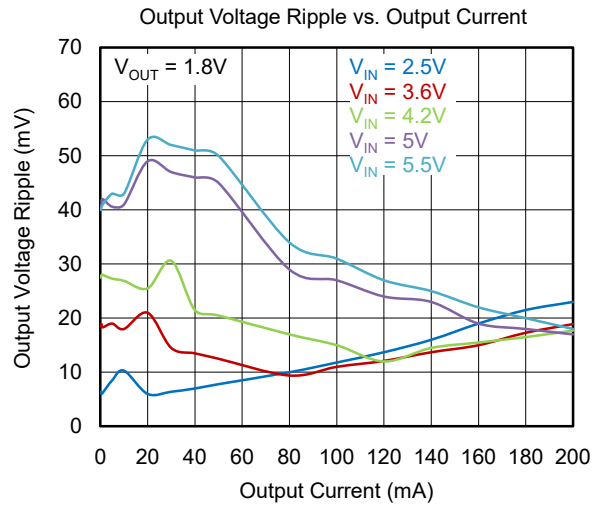
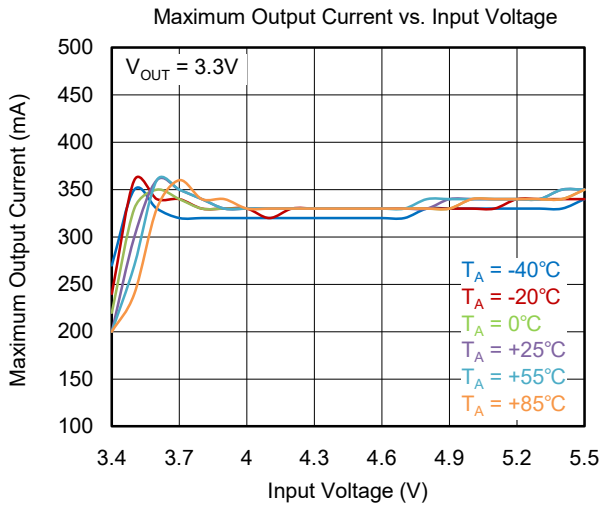

FUNCTIONAL BLOCK DIAGRAM

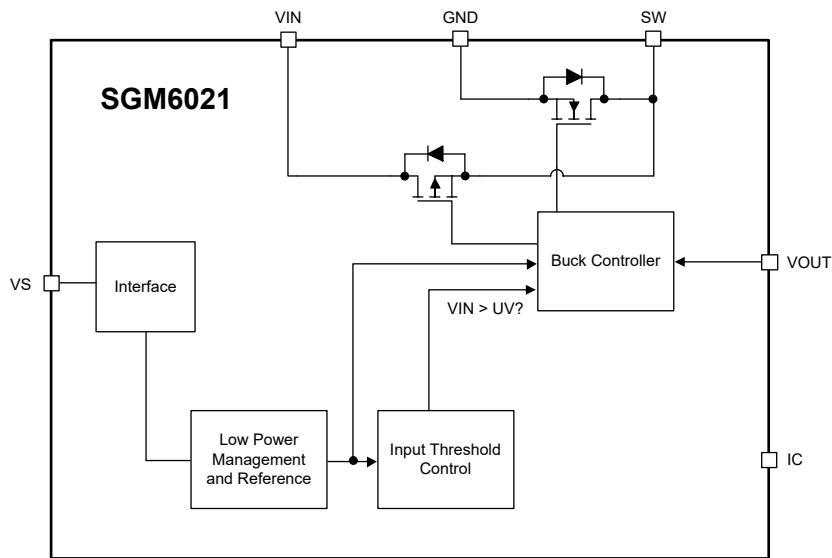

Figure 2. Block Diagram

DETAILED DESCRIPTION

The SGM6021 family is a synchronous Buck converter with ultra-low quiescent current of 400nA (TYP). The device is improved to provide high efficiency ranging from 10µA to 200mA. The SGM6021 family equips an externally regulated supply that is programmable. Thus, the power-management stage efficiency is maintained.

The SGM6021 implements the hysteretic control architecture to regulate the output voltage. The 400nA (TYP) quiescent current extends the operation lifetime for battery operated applications.

Operation

The SGM6021 family is a Buck converter that is capable to regulate the voltage that is lower than the input voltage at the output. The device implements the pulse frequency modulation (PFM) control to regulate the voltage at light load. The SGM6021 delivers an

average output current of 200mA with a peak inductor current of 430mA (TYP). The device implements an input under-voltage lockout (UVLO) function. When the input voltage drops below the UVLO threshold, the device stops operation. In addition to input UVLO function, the SGM6021 also implements the VS pin to allow external signal to control the turn-on and turn-off of the device. The device also implements output discharge function, when the VS pin is pulled to logic low, the low-side power FET remains on to discharge the output voltage. The SGM6021 also implements 100% duty cycle mode to bypass the input voltage to the output when the input voltage is above the UVLO threshold.

DETAILED DESCRIPTION (continued)

Effective Pulse at VS Pin

A pulse with width less than t_{PULSE} is treated as an effective pulse. Consecutive pulses will be counted if delay between adjacent pulses is within the t_{STOP} . Please refer to Figure 3 for a graphical explanation.

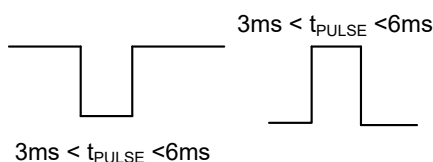

Figure 3. Effective Pulse at VS Pin

VS Pin Interface Functions

In order to enable the IC from shutdown mode, two conditions must be met:

1. VIN voltage is higher than UVLO threshold.
2. VS pin is floating or VS pin stays logic high for at least $t_{BLANK} + t_{SS}$ time.

After that, the pulses at VS pin become effective and can be used to shut down the IC or program the output voltage. The following are the three cases that the VS pin affects the regulator:

1. 1 pulse followed by VS pin being low for longer than t_{OFF} will shut down the regulator.

During the $t_{OFF-HOLD}$ time after shutdown, the pulses applied to VS Pin are ignored.

To restart the regulator, the VS pin must be pulled high for at least t_{SS} time.

2. 2~5 pulses followed by VS pin being high for longer than t_{OFF} will set the output voltage to the default, V1, V2 and V3 respectively.

3. 2 or more pulses followed by VS pin being low for longer than t_{OFF} will set the output voltage to the default value.

Other pulse patterns will have no effects on the IC.

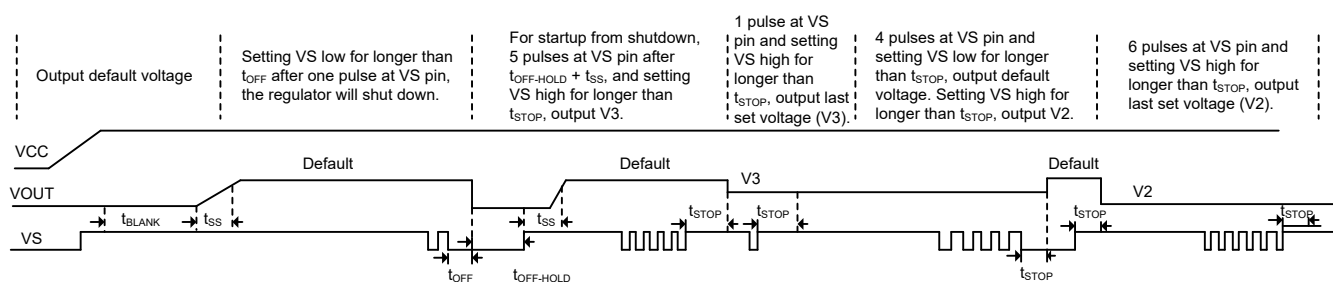

Figure 4. Program Output Voltage via VS Pin

Under-Voltage Lockout (UVLO)

The device monitors the input voltage and shuts down itself when the input voltage is lower than UVLO threshold voltage. When the input voltage is higher than the UVLO threshold plus hysteresis, the device will start again.

Thermal Shutdown (TSD)

A thermal shutdown function is implemented to prevent the damage caused by excessive heat and power dissipation. Once a temperature of +160°C (TYP) is exceeded, the device is shut down. The device is

released from shutdown automatically when the junction temperature decreases by 20°C.

Nano-Power Management and Efficiency

The SGM6021 implements the nano-power circuitry and algorithm to achieve 400nA (TYP) quiescent current. This feature is accomplished through sampling and all references are saved, so as to lower the average quiescent current. During the sampling and saving, the internal circuits are only turned on for a short period of time and then turned off in the remaining time at the lowest feasible duty cycle.

APPLICATION INFORMATION

The SGM6021 family has ultra-low quiescent current and is capable of delivering up to 200mA load current, which is suitable for battery operated applications.

Design Procedure

A 10 μ H inductor (Toko DFE2520- 12C) and a 22 μ F input ceramic capacitor are recommended for the SGM6021. Since the device only supports 200mA output load, a 22 μ F output ceramic capacitor is sufficient. For applications that are expected to have a large transient event, use $I_{TRAN} = C_{OUT} \times \Delta V_{OUT} / \Delta T_{TIME}$ to size the output capacitor accordingly, where ΔV_{OUT} is

the amount of output voltage drop during load step.

Inductor Selection

The SGM6021 is optimized to work with a 4.7 μ H inductor. The selected inductor's saturation current should be at least 25% higher than the maximum cycle-by-cycle current limit specified in the Electrical Characteristics table. The SGM6021 is naturally stable due to its hysteretic control architecture.

The recommended inductors for SGM6021 are shown in Table 1.

Table 1. Recommended Inductors

INDUCTANCE (μ H)	DIMENSIONS (mm)	PART NUMBER	MANUFACTURER
10	2.0 × 2.5 × 1.2	DFE252012C-H-100M	Toko
10	4.0 × 4.0 × 1.7	LPS4018-103M	Coilcraft

Output Capacitor Selection

A minimal of 22 μ F ceramic output capacitor is recommended for SGM6021. Larger size will result in higher effective capacitance under the same DC de-rating, which improves the transient response and output ripple.

Input Capacitor Selection

A 22 μ F ceramic capacitor and a 0.1 μ F ceramic bypass input capacitor are recommended to place between the VIN pin and GND as close as possible to minimize the parasitic inductance. For applications where the SGM6021 is located far away from the input source, a 22 μ F or higher capacitor is recommended to damp the inductance of the wiring harness.

REVISION HISTORY

NOTE: Page numbers for previous revisions may differ from page numbers in the current version.

OCTOBER 2022 – REV.A.1 to REV.A.2	Page
Updated the Detailed Description and Application Information sections	9, 11
<hr/>	
AUGUST 2017 – REV.A to REV.A.1	Page
Changed SGM6021-4 STATUS from PREVIEW to ACTIVE	2
<hr/>	
Changes from Original (JUNE 2017) to REV.A	Page
Changed from product preview to production data	All

PACKAGE OUTLINE DIMENSIONS

UTDFN-1.5x2-6L

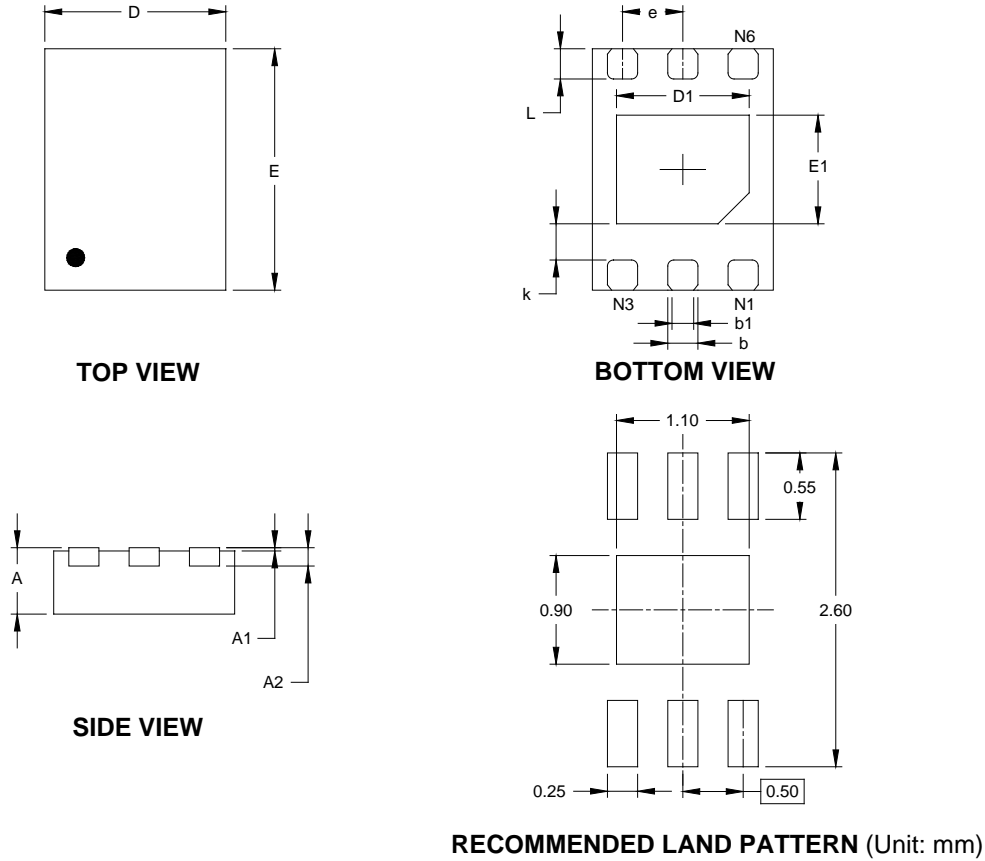

RECOMMENDED LAND PATTERN (Unit: mm)

Symbol	Dimensions In Millimeters		Dimensions In Inches	
	MIN	MAX	MIN	MAX
A	0.500	0.600	0.020	0.024
A1	0.000	0.050	0.000	0.002
A2	0.152 REF		0.006 REF	
D	1.400	1.600	0.055	0.063
D1	1.000	1.200	0.039	0.047
E	1.900	2.100	0.075	0.083
E1	0.800	1.000	0.031	0.039
k	0.300 REF		0.012 REF	
b	0.200	0.300	0.008	0.012
b1	0.180 REF		0.007 REF	
e	0.500 BSC		0.020 BSC	
L	0.200	0.300	0.008	0.012

NOTE: This drawing is subject to change without notice.

PACKAGE INFORMATION

TAPE AND REEL INFORMATION

REEL DIMENSIONS



TAPE DIMENSIONS



NOTE: The picture is only for reference. Please make the object as the standard.

KEY PARAMETER LIST OF TAPE AND REEL

Package Type	Reel Diameter	Reel Width W1 (mm)	A0 (mm)	B0 (mm)	K0 (mm)	P0 (mm)	P1 (mm)	P2 (mm)	W (mm)	Pin1 Quadrant
UTDFN-1.5×2-6L	7"	9.5	1.70	2.30	0.75	4.0	4.0	2.0	8.0	Q2

000001

PACKAGE INFORMATION

CARTON BOX DIMENSIONS



NOTE: The picture is only for reference. Please make the object as the standard.

KEY PARAMETER LIST OF CARTON BOX

Reel Type	Length (mm)	Width (mm)	Height (mm)	Pizza/Carton
7" (Option)	368	227	224	8
7"	442	410	224	18

DD0002