



# SGM6019

## 1.2A, 1.6MHz, High Efficiency Synchronous Step-Down Converter

### GENERAL DESCRIPTION

SGM6019 is a high-efficient integrated step-down regulator with 1.2A guaranteed output current. This device is capable to provide an input voltage range of 2.7V to 5.5V, making the use of single-cell Li-Ion battery, three NiMH cells battery or a regulated 5V input possible.

In heavy load condition, this device can work in the forced pulse width modulation (PWM) mode with a switching frequency of 1.6MHz (TYP). In addition, it also can work in the skip mode with 30 $\mu$ A low quiescent current. The 95% high efficiency at light load allows it to be highly efficient to conserve the battery life of devices. Thus, the SGM6019 is specified for the compact devices with low-voltage microprocessor power supply requirements. The SGM6019 also includes the features of internal digital soft-start, peak current limit, short circuit protection and over-temperature protection.

SGM6019 is available in the Green TDFN-2 $\times$ 3-8L package. It is rated over the -40 $^{\circ}$ C to +85 $^{\circ}$ C temperature range.

### FEATURES

- 2.7V to 5.5V Input Voltage Range
- 95% Peak Efficiency
- 1.2A Guaranteed Output Current
- 3.7% Output Accuracy Over Temperature
- Programmable Forced PWM Mode and Skip Mode
- 30 $\mu$ A Low Quiescent Current in Skip Mode
- Less than 1 $\mu$ A Shutdown Current
- 100% Duty Cycle for Lowest Dropout
- Discharge Output Capacitor in Shutdown
- Internal Soft-Start and Peak Current Limit
- Short Circuit and Over-Temperature Protection
- Enable and Power-Good Functions
- Available in a Green TDFN-2 $\times$ 3-8L Package

### APPLICATIONS

Single Li- Ion Battery-Powered Equipment  
DSP Core Power  
Mobile Phones  
GPS and Laptops

**PACKAGE/ORDERING INFORMATION**

MODEL	PACKAGE DESCRIPTION	SPECIFIED TEMPERATURE RANGE	ORDERING NUMBER	PACKAGE MARKING	PACKING OPTION
SGM6019	TDFN-2×3-8L	-40°C to +85°C	SGM6019YTDC8G/TR	6019 XXXX	Tape and Reel, 3000

**MARKING INFORMATION**

NOTE: XXXX= Date Code, Trace Code and Vendor Code.

**XXXX**

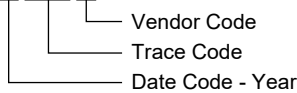

Green (RoHS & HSF): SG Micro Corp defines "Green" to mean Pb-Free (RoHS compatible) and free of halogen substances. If you have additional comments or questions, please contact your SGMICRO representative directly.

**ABSOLUTE MAXIMUM RATINGS**

- VIN.....-0.3V to 6V
- FB, SW, EN, MODE, PG.....-0.3V to V<sub>IN</sub> + 0.3V
- Operating Temperature Range.....-40°C to +85°C
- Junction Temperature.....150°C
- Storage Temperature Range.....-65°C to +150°C
- Package Thermal Resistance
- TDFN-2×3-8L, θ<sub>JA</sub>..... 75°C/W
- Lead Temperature (Soldering, 10s) .....260°C
- ESD Susceptibility
- HBM..... 3000V
- MM..... 200V

**RECOMMENDED OPERATING CONDITIONS**

- Operating Temperature Range .....-40°C to +85°C

**OVERSTRESS CAUTION**

Stresses beyond those listed in Absolute Maximum Ratings may cause permanent damage to the device. Exposure to absolute maximum rating conditions for extended periods may affect reliability. Functional operation of the device at any conditions beyond those indicated in the Recommended Operating Conditions section is not implied.

**ESD SENSITIVITY CAUTION**

This integrated circuit can be damaged if ESD protections are not considered carefully. SGMICRO recommends that all integrated circuits be handled with appropriate precautions. Failure to observe proper handling and installation procedures can cause damage. ESD damage can range from subtle performance degradation to complete device failure. Precision integrated circuits may be more susceptible to damage because even small parametric changes could cause the device not to meet the published specifications.

**DISCLAIMER**

SG Micro Corp reserves the right to make any change in circuit design, or specifications without prior notice.

## PIN CONFIGURATION

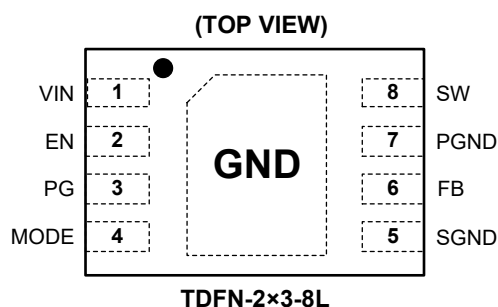

## PIN DESCRIPTION

PIN	NAME	FUNCTION
1	VIN	Input Supply Voltage. Put a 10 $\mu$ F ceramic capacitor from this pin to power ground.
2	EN	Enable Pin. When pulling this pin high, the device enables. When pulling low, the device stops and the output capacitor discharged. Do not leave it floating.
3	PG	Power-Good Signal.
4	MODE	Mode Selection Pin. For skip mode, connect it to logic high. Forced PWM mode, connect it to logic low. Do not leave this pin floating.
5	SGND	Ground of Analog Signal. It must be connected to external GND
6	FB	Output Feedback Pin. A voltage divider resistor is used between this pin and the output for adjustable output voltage.
7	PGND	Power Ground. Connect all power grounds to this pin.
8	SW	Switching Node Connection. Connected to one terminal of inductor.
Exposed Pad	GND	Strongly recommend to connect it to PGND pin for better electrical and optimal thermal performance.

## ELECTRICAL CHARACTERISTICS

( $V_{IN} = V_{EN} = V_{MODE} = 3.6V$ ,  $L_1 = 2.2\mu H$ ,  $C_{IN} = C_{OUT} = 10\mu F$ ,  $I_{OUT} = 0A$ , Full =  $-40^{\circ}C$  to  $+85^{\circ}C$ , typical values are at  $T_A = +25^{\circ}C$ , unless otherwise noted.)

PARAMETER	SYMBOL	CONDITIONS	TEMP	MIN	TYP	MAX	UNITS
Input Voltage Range	$V_{IN}$		Full	2.7		5.5	V
Feedback Input Bias Current	$I_{FB}$	$V_{FB} = 0.75V$	$+25^{\circ}C$		0.1		$\mu A$
Regulated Feedback Voltage	$V_{FB}$	$T_A = 0^{\circ}C$ to $+85^{\circ}C$		0.777	0.800	0.823	V
			Full	0.774	0.800	0.826	
Quiescent Current	$I_Q$	MODE = $V_{IN}$ , no load at the output	$+25^{\circ}C$		30	60	$\mu A$
		MODE = AGND, no load at the output			3.5	4.5	mA
Shutdown Current	$I_{SD}$	$V_{IN} = 5.5V$ , EN = LOW	$+25^{\circ}C$		0.05	1	$\mu A$
Under-Voltage Lockout Threshold	$V_{UVLO}$	Rising	$+25^{\circ}C$		2.35	2.68	V
		Falling			2.1	2.25	
Output Voltage Accuracy		$V_{IN} = 3.6V$ , $I_{OUT} = 200mA$ , $V_{OUT} = 1.6V$	Full	-3.7		3.7	%
Output Voltage Line Regulation	$\Delta V_{OUT}$	$V_{IN} = 2.7V$ to $5.5V$ , $V_{OUT} = 1.6V$	Full		0.2		%/V
Maximum Output Current			$+25^{\circ}C$	1.2			A
Error Amplifier Transconductance	gm	Design info only	$+25^{\circ}C$		13		$\mu A/V$
P-Channel MOSFET On-Resistance		$V_{IN} = 3.6V$ , $I_{OUT} = 200mA$	$+25^{\circ}C$		0.15	0.30	$\Omega$
		$V_{IN} = 2.7V$ , $I_{OUT} = 200mA$			0.18	0.32	
N-Channel MOSFET On-Resistance		$V_{IN} = 3.6V$ , $I_{OUT} = 200mA$	$+25^{\circ}C$		0.12	0.30	$\Omega$
		$V_{IN} = 2.7V$ , $I_{OUT} = 200mA$			0.13	0.32	
N-Channel Bleeding MOSFET On-Resistance			$+25^{\circ}C$		90		$\Omega$
P-Channel MOSFET Peak Current Limit	$I_{PK}$	$V_{IN} = 5.5V$	$+25^{\circ}C$	1.40	1.75	2.10	A
Maximum Duty Cycle			$+25^{\circ}C$		100		%
PWM Switching Frequency	$f_S$		Full	1.3	1.6	1.8	MHz
SW Minimum On Time		MODE = LOW (forced PWM mode)	$+25^{\circ}C$		160		ns
Soft Start-Up Time			$+25^{\circ}C$		1.1		ms
PG Pin Output Low Voltage		Sinking 1mA, $V_{FB} = 0.7V$	$+25^{\circ}C$			0.3	V
PG Pin Delay Time			$+25^{\circ}C$	170	215	260	ms
PG Pin Leakage Current		PG = $V_{IN} = 3.6V$	$+25^{\circ}C$		0.01	1	$\mu A$
Minimum Supply Voltage for Valid PG Signal			$+25^{\circ}C$	1.2			V
Internal PGOOD Low Rising Threshold		Percentage of nominal regulation voltage	$+25^{\circ}C$	89	92	95	%
Internal PGOOD Low Falling Threshold		Percentage of nominal regulation voltage	$+25^{\circ}C$	85	88	91	%
Internal PGOOD High Rising Threshold		Percentage of nominal regulation voltage	$+25^{\circ}C$	109	112	115	%
Internal PGOOD High Falling Threshold		Percentage of nominal regulation voltage	$+25^{\circ}C$	105.5	108.5	111.5	%
Internal PGOOD Delay Time			$+25^{\circ}C$		50		$\mu s$
Logic Input Low Voltage	$V_{IL}$		$+25^{\circ}C$			0.4	V
Logic Input High Voltage	$V_{IH}$		$+25^{\circ}C$	1.5			V
Logic Input Leakage Current		Pulled up to 5.5V	$+25^{\circ}C$		0.1	1	$\mu A$
Thermal Shutdown			$+25^{\circ}C$		150		$^{\circ}C$
Thermal Shutdown Hysteresis			$+25^{\circ}C$		15		$^{\circ}C$

TYPICAL PERFORMANCE CHARACTERISTICS

$V_{IN} = V_{EN} = V_{MODE} = 3.6V$ ,  $L_1 = 2.2\mu H$ ,  $C_{IN} = C_{OUT} = 10\mu F$ ,  $I_{OUT} = 0A$ ,  $T_A = +25^\circ C$ , unless otherwise noted

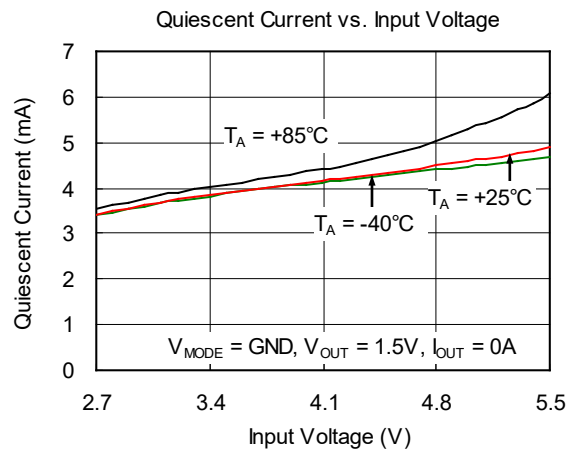
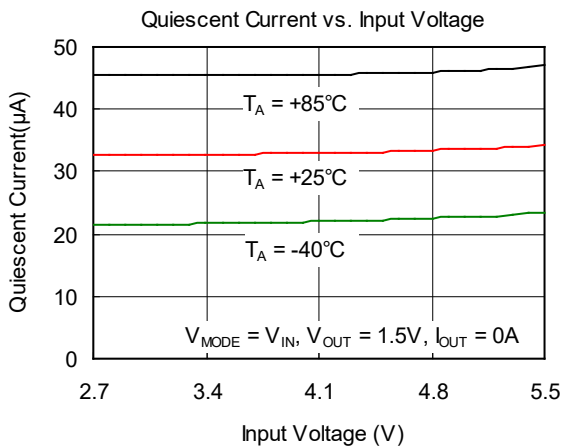
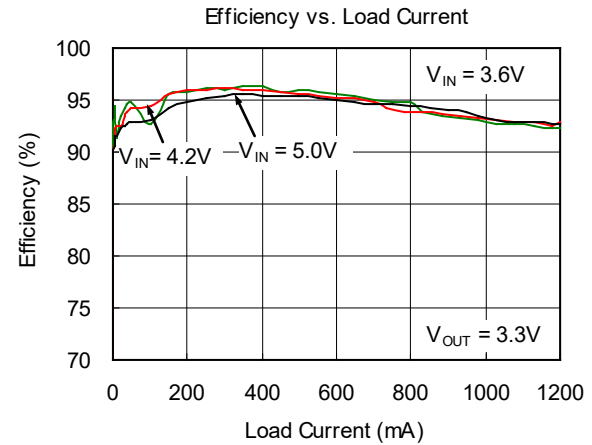
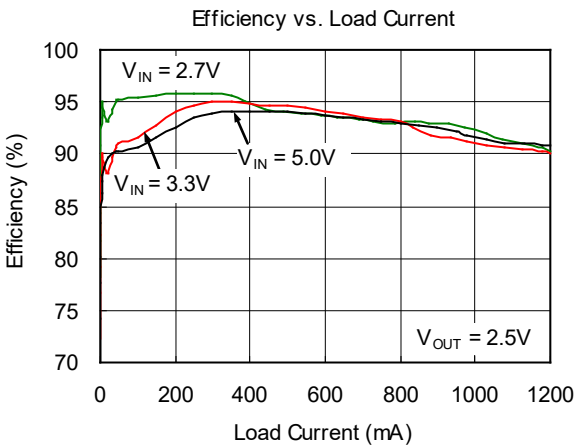
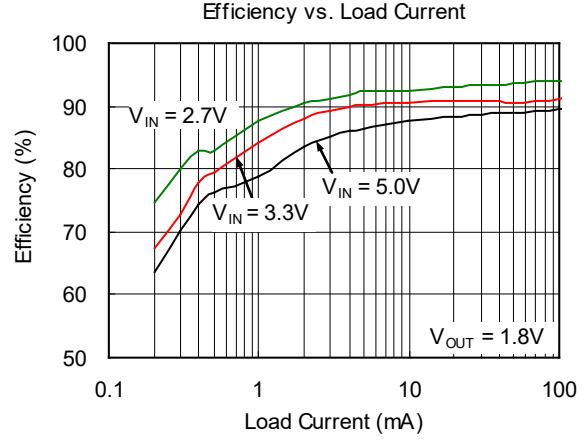
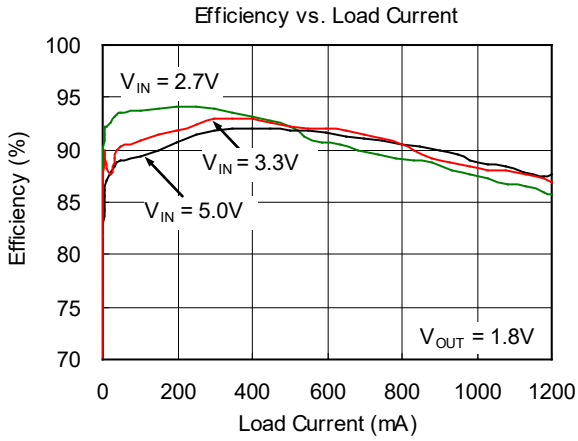

TYPICAL PERFORMANCE CHARACTERISTICS (continued)

$V_{IN} = V_{EN} = V_{MODE} = 3.6V$ ,  $V_{RSI} = 0V$ ,  $L1 = 2.2\mu H$ ,  $C_{IN} = C_{OUT} = 10\mu F$ ,  $I_{OUT} = 0A$ ,  $T_A = +25^\circ C$ , unless otherwise noted.

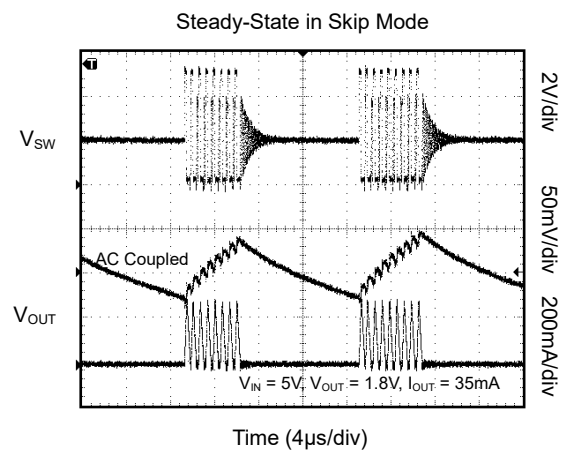
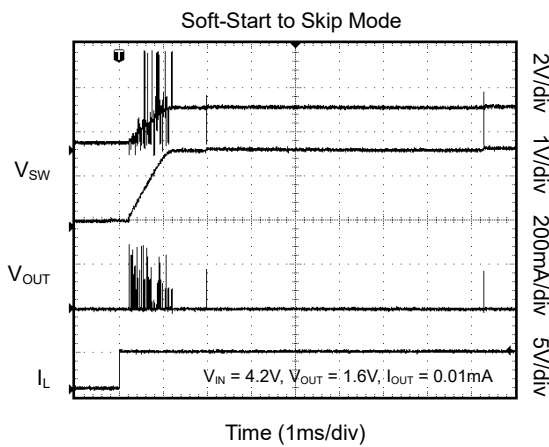
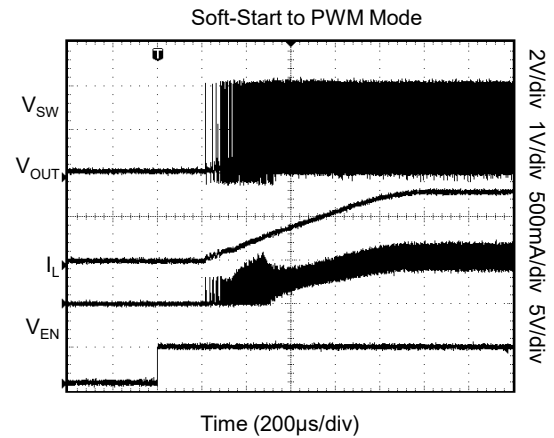
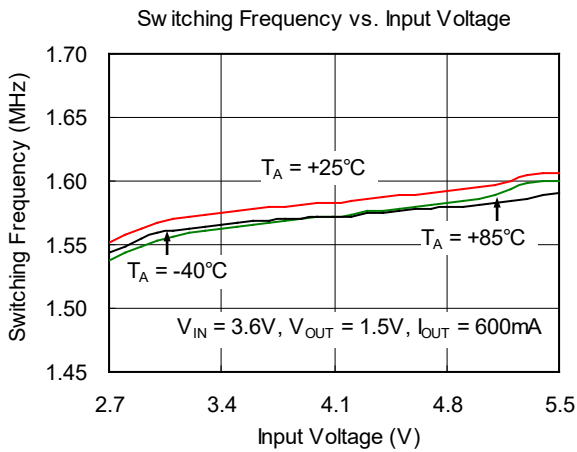
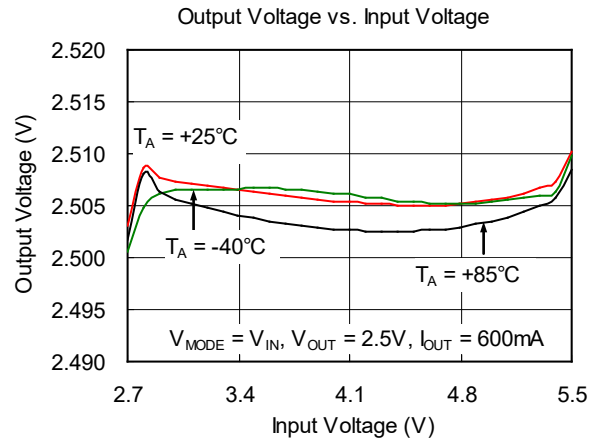
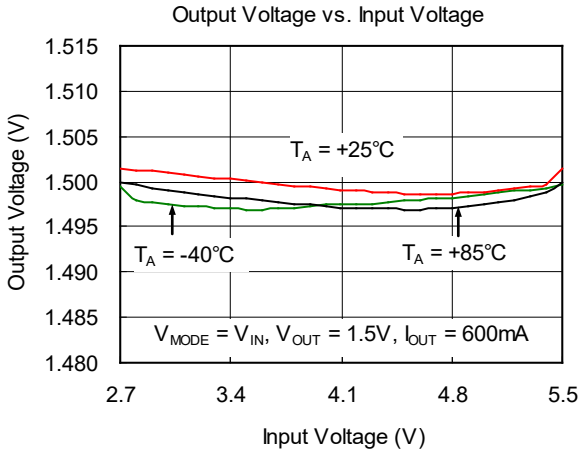

TYPICAL PERFORMANCE CHARACTERISTICS (continued)

$V_{IN} = V_{EN} = V_{MODE} = 3.6V$ ,  $L_1 = 2.2\mu H$ ,  $C_{IN} = C_{OUT} = 10\mu F$ ,  $I_{OUT} = 0A$ ,  $T_A = +25^\circ C$ , unless otherwise noted.

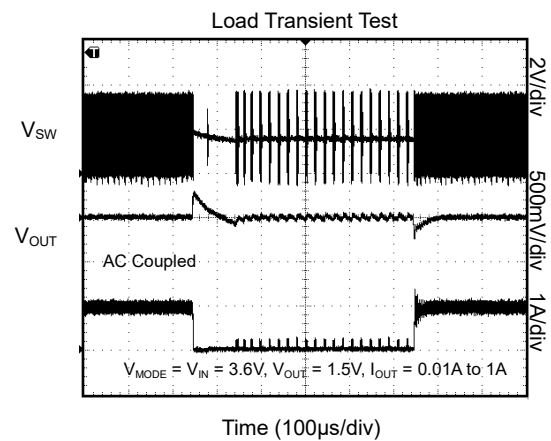
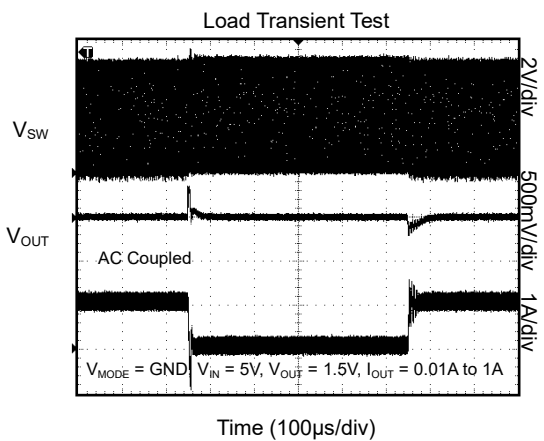
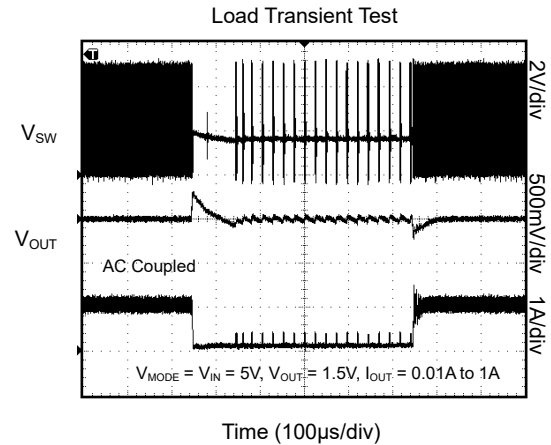
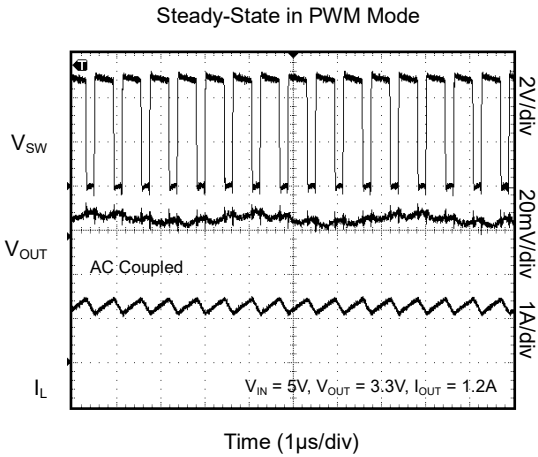
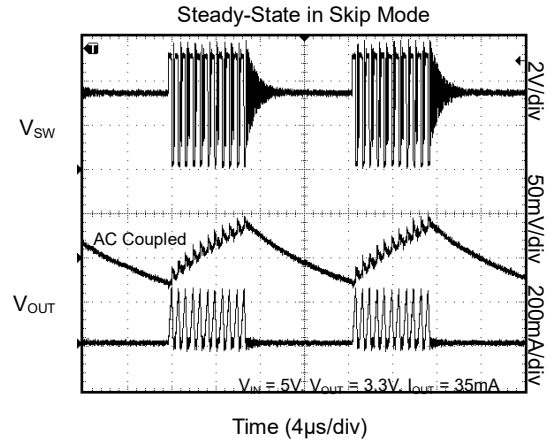
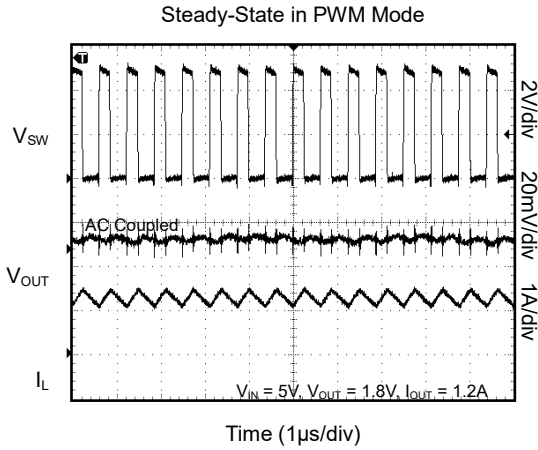

TYPICAL PERFORMANCE CHARACTERISTICS (continued)

$V_{IN} = V_{EN} = V_{MODE} = 3.6V$ ,  $L1 = 2.2\mu H$ ,  $C_{IN} = C_{OUT} = 10\mu F$ ,  $I_{OUT} = 0A$ ,  $T_A = +25^\circ C$ , unless otherwise noted.

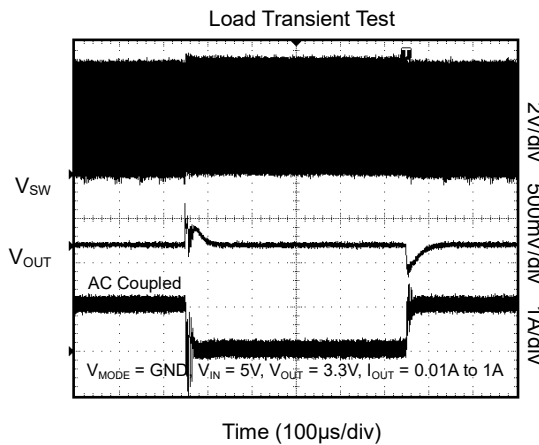
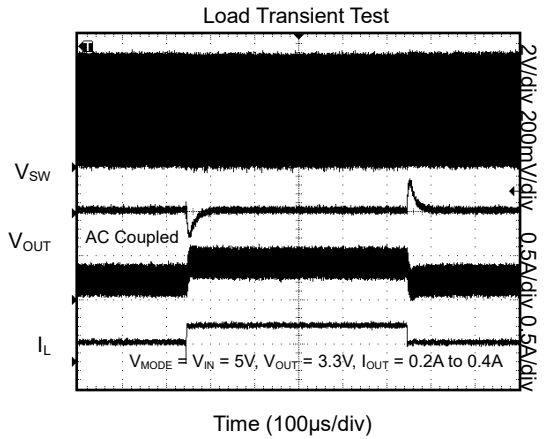
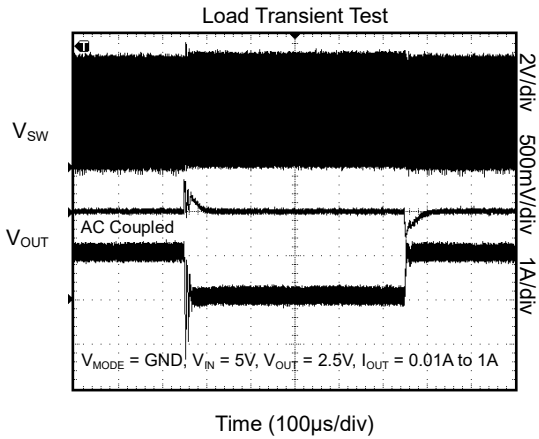
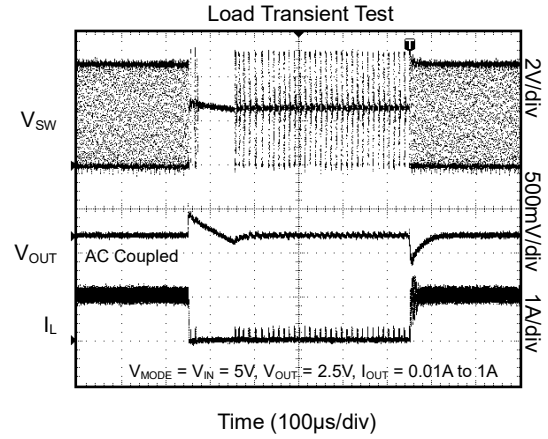
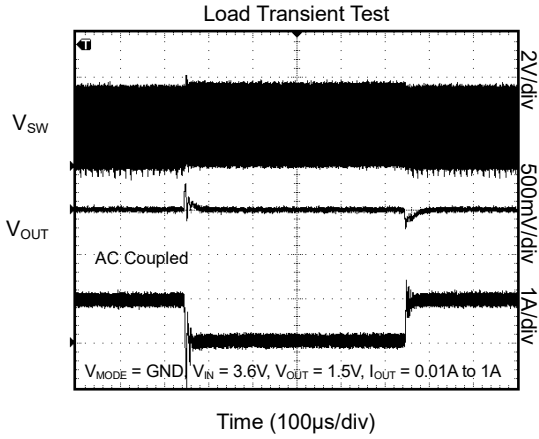



**REVISION HISTORY**

NOTE: Page numbers for previous revisions may differ from page numbers in the current version.

**Changes from Original (SEPTEMBER 2013) to REV.A**

**Page**

---

Changed from product preview to production data.....All

---

PACKAGE OUTLINE DIMENSIONS

TDFN-2x3-8L

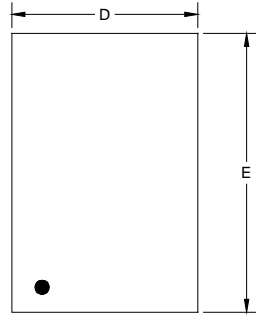

TOP VIEW

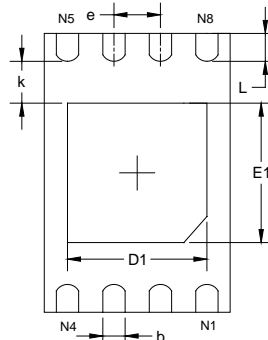

BOTTOM VIEW

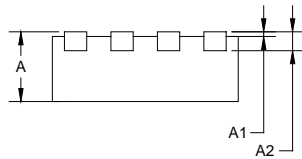

SIDE VIEW

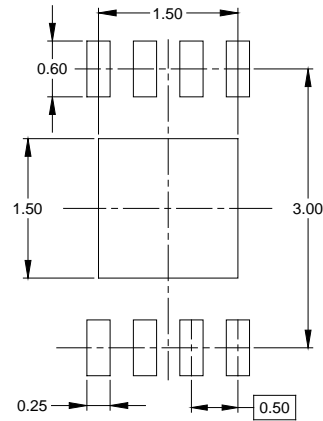

RECOMMENDED LAND PATTERN (Unit: mm)

Symbol	Dimensions In Millimeters		Dimensions In Inches	
	MIN	MAX	MIN	MAX
A	0.700	0.800	0.028	0.031
A1	0.000	0.050	0.000	0.002
A2	0.203 REF		0.008 REF	
D	1.924	2.076	0.076	0.082
D1	1.400	1.600	0.055	0.063
E	2.924	3.076	0.115	0.121
E1	1.400	1.600	0.055	0.063
k	0.200 MIN		0.008 MIN	
b	0.200	0.300	0.008	0.012
e	0.500 TYP		0.020 TYP	
L	0.224	0.376	0.009	0.015

NOTE: This drawing is subject to change without notice.

# PACKAGE INFORMATION

## TAPE AND REEL INFORMATION

### REEL DIMENSIONS



### TAPE DIMENSIONS



NOTE: The picture is only for reference. Please make the object as the standard.

### KEY PARAMETER LIST OF TAPE AND REEL

Package Type	Reel Diameter	Reel Width W1 (mm)	A0 (mm)	B0 (mm)	K0 (mm)	P0 (mm)	P1 (mm)	P2 (mm)	W (mm)	Pin1 Quadrant
TDFN-2×3-8L	7"	9.5	2.30	3.30	1.10	4.0	4.0	2.0	8.0	Q2

000001

# PACKAGE INFORMATION

## CARTON BOX DIMENSIONS



NOTE: The picture is only for reference. Please make the object as the standard.

## KEY PARAMETER LIST OF CARTON BOX

Reel Type	Length (mm)	Width (mm)	Height (mm)	Pizza/Carton
7" (Option)	368	227	224	8
7"	442	410	224	18

DD0002