



SGM8425/SGM8426/SGM8428 18MHz, High Voltage, Rail-to-Rail I/O Operational Amplifiers

GENERAL DESCRIPTION

The SGM8425 (single), SGM8426 (dual) and SGM8428 (quad) are low power operational amplifiers optimized for high voltage systems. These devices can operate from 4.5V to 30V single supply or from $\pm 2.25V$ to $\pm 15V$ dual power supplies, and each amplifier consumes only 1.6mA quiescent current. They support rail-to-rail input and output operation, which results in wide dynamic range. The SGM8425/6/8 are suitable for low power systems, such as portable and battery-powered applications.

The SGM8425/6/8 have a bandwidth of 18MHz at -3dB. They offer fast settling and slewing times. These devices are well suited for TFT-LCDs.

The SGM8425 is available in Green SOT-23-5, SOIC-8 and MSOP-8 packages. The SGM8426 is available in Green SOIC-8 and MSOP-8 packages. The SGM8428 is available in Green TSSOP-14 and SOIC-14 packages. They are rated over the -40°C to +85°C temperature range.

FEATURES

- Rail-to-Rail Input and Output
- -3dB Bandwidth: 18MHz
- High Slew Rate: 16V/ μ s
- Supply Current: 1.6mA/Amplifier
- -40°C to +85°C Operating Temperature Range
- Small Packaging:
 - SGM8425 Available in SOT-23-5, SOIC-8 and MSOP-8 Packages
 - SGM8426 Available in SOIC-8 and MSOP-8 Packages
 - SGM8428 Available in SOIC-14 and TSSOP-14 Packages

APPLICATIONS

TFT-LCD Drive Circuits
Laptops
Touch-Screen Monitors
Electronics Games
WLANS
Office Automation
Personal Communication Equipment
PDAs
Portable Equipment
A/D Converter Buffers
Active Filters

PACKAGE/ORDERING INFORMATION

MODEL	PACKAGE DESCRIPTION	SPECIFIED TEMPERATURE RANGE	ORDERING NUMBER	PACKAGE MARKING	PACKING OPTION
SGM8425	SOT-23-5	-40°C to +85°C	SGM8425AYN5G/TR	SN9XX	Tape and Reel, 3000
	SOT-23-5	-40°C to +85°C	SGM8425BYN5G/TR	SICXX	Tape and Reel, 3000
	SOIC-8	-40°C to +85°C	SGM8425YS8G/TR	SGM 8425YS8 XXXXX	Tape and Reel, 2500
	MSOP-8	-40°C to +85°C	SGM8425YMS8G/TR	SGM8425 YMS8 XXXXX	Tape and Reel, 3000
SGM8426	SOIC-8	-40°C to +85°C	SGM8426YS8G/TR	SGM 8426YS8 XXXXX	Tape and Reel, 2500
	MSOP-8	-40°C to +85°C	SGM8426YMS8G/TR	SGM8426 YMS8 XXXXX	Tape and Reel, 3000
SGM8428	SOIC-14	-40°C to +85°C	SGM8428YS14G/TR	SGM8428YS14 XXXXX	Tape and Reel, 2500
	TSSOP-14	-40°C to +85°C	SGM8428YTS14G/TR	SGM8428 YTS14 XXXXX	Tape and Reel, 3000

MARKING INFORMATION

NOTE: XX = Date Code. XXXXX = Date Code and Vendor Code.

SOT-23-5

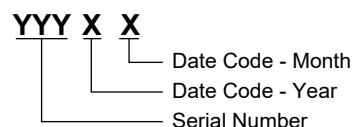

SOIC-8/MSOP-8/SOIC-14/TSSOP-14

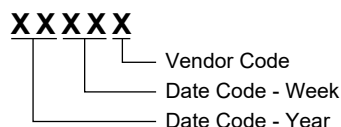

Green (RoHS & HSF): SG Micro Corp defines "Green" to mean Pb-Free (RoHS compatible) and free of halogen substances. If you have additional comments or questions, please contact your SGMICRO representative directly.

ABSOLUTE MAXIMUM RATINGS

Supply Voltage, +V _S to -V _S	32V
Input Common Mode Voltage Range	(-V _S) - 0.1V to (+V _S) + 0.1V
Input/Output Voltage Range	(-V _S) - 0.3V to (+V _S) + 0.3V
Junction Temperature	+150°C
Storage Temperature Range	-65°C to +150°C
Lead Temperature (Soldering, 10s)	+260°C
ESD Susceptibility	
HBM (SGM8425/6)	3000V
MM (SGM8425/6)	150V
HBM (SGM8428)	4000V
MM (SGM8428)	250V

RECOMMENDED OPERATING CONDITIONS

Operating Temperature Range	-40°C to +85°C
-----------------------------------	----------------

OVERSTRESS CAUTION

Stresses beyond those listed in Absolute Maximum Ratings may cause permanent damage to the device. Exposure to absolute maximum rating conditions for extended periods may affect reliability. Functional operation of the device at any conditions beyond those indicated in the Recommended Operating Conditions section is not implied.

ESD SENSITIVITY CAUTION

This integrated circuit can be damaged if ESD protections are not considered carefully. SGMICRO recommends that all integrated circuits be handled with appropriate precautions. Failure to observe proper handling and installation procedures can cause damage. ESD damage can range from subtle performance degradation to complete device failure. Precision integrated circuits may be more susceptible to damage because even small parametric changes could cause the device not to meet the published specifications.

DISCLAIMER

SG Micro Corp reserves the right to make any change in circuit design, or specifications without prior notice.

PIN CONFIGURATIONS

SGM8425AYN5G (TOP VIEW)

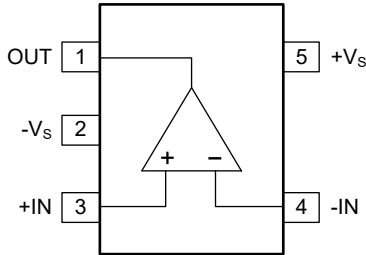

SOT-23-5

SGM8425BYN5G (TOP VIEW)

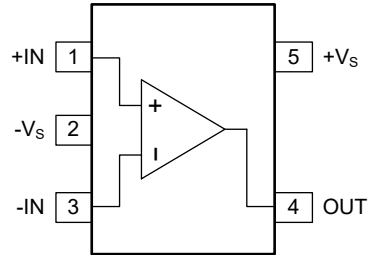

SOT-23-5

SGM8425 (TOP VIEW)

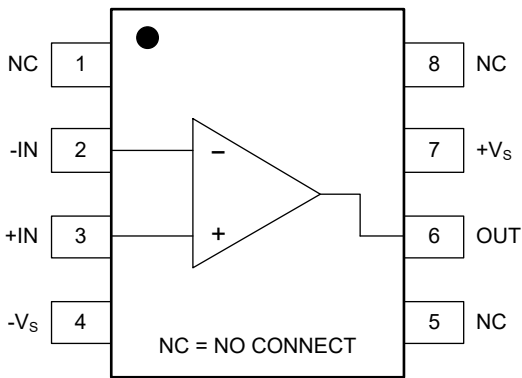

SOIC-8/MSOP-8

SGM8426 (TOP VIEW)

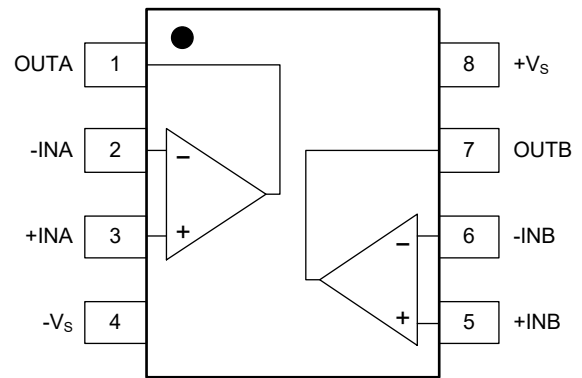

SOIC-8/MSOP-8

SGM8428 (TOP VIEW)

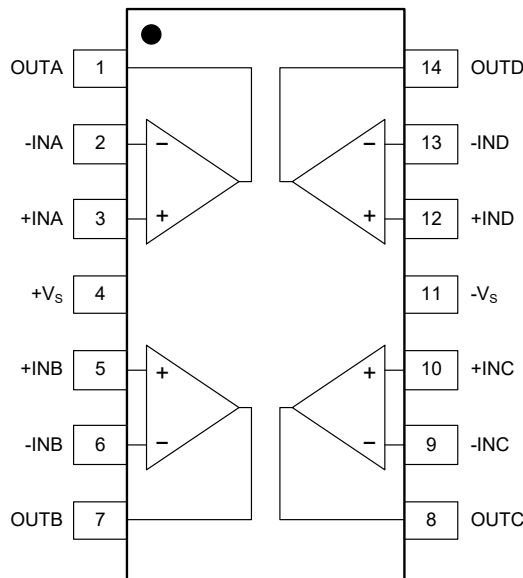

SOIC-14/TSSOP-14

ELECTRICAL CHARACTERISTICS

(At $T_A = +25^\circ\text{C}$, $V_S = 5\text{V}$, $R_L = 2\text{k}\Omega$ connected to $V_S/2$, $V_{OUT} = V_S/2$, unless otherwise noted.)

PARAMETER	CONDITIONS	SGM8425/6/8					
		TYP	MIN/MAX OVER TEMPERATURE			UNITS	MIN/ MAX
		+25°C	+25°C	-40°C to +85°C			
Input Characteristics							
Input Offset Voltage (V_{OS})	$V_{CM} = V_S/2$	1.0	6.5	7.5	mV	MAX	
Input Offset Voltage Drift ($\Delta V_{OS}/\Delta T$)		4.9			$\mu\text{V}/^\circ\text{C}$	TYP	
Input Common Mode Voltage Range (V_{CM})		-0.1 to 5.1			V	TYP	
Common Mode Rejection Ratio (CMRR)	$V_{CM} = -0.1\text{V to } 5.1\text{V}$	62	47	45	dB	MIN	
Open-Loop Voltage Gain (A_{OL})	$V_{OUT} = 0.5\text{V to } 4.5\text{V}$	94	77	75	dB	MIN	
Output Characteristics							
Output Voltage Swing from Rail	V_{OH} $I_{OUT} = 5\text{mA}$	78	116	161	mV	MAX	
	V_{OL} $I_{OUT} = -5\text{mA}$	83	120	165	mV	MAX	
Output Short-Circuit Current (I_{SC})	Sink $R_L = 10\Omega \text{ to } V_S/2$	93	72		mA	MIN	
	Source $R_L = 10\Omega \text{ to } V_S/2$	97	74				
Power Supply							
Power Supply Rejection Ratio (PSRR)	$V_S = 4.5\text{V to } 30\text{V}$, $V_{CM} = V_S/2$	98	84	78	dB	MIN	
Quiescent Current/Amplifier (I_Q)	$I_{OUT} = 0\text{A}$	1.5	2.1	3.3	mA	MAX	
Dynamic Performance							
Gain-Bandwidth Product (GBP)	$R_L = 10\text{k}\Omega$, $C_L = 10\text{pF}$, $V_{CM} = V_S/2$	9			MHz	TYP	
-3dB Bandwidth (BW)	$R_L = 10\text{k}\Omega$, $C_L = 10\text{pF}$, $V_{CM} = V_S/2$	18			MHz	TYP	
Slew Rate (SR)	$V_{OUT} = 2V_{PP}$ step, $A_V = 1$	13			$\text{V}/\mu\text{s}$	TYP	
Phase Margin	$R_L = 10\text{k}\Omega$, $C_L = 10\text{pF}$, $V_{CM} = V_S/2$	35			$^\circ$	TYP	
Gain Margin	$R_L = 10\text{k}\Omega$, $C_L = 10\text{pF}$, $V_{CM} = V_S/2$	-5			dB	TYP	
Crosstalk	$f = 5\text{MHz}$	78			dB	TYP	
Settling Time (t_s)	$V_{OUT} = 2V_{PP}$ step, $A_V = 1$	0.37			μs	TYP	
Noise Performance							
Input Voltage Noise Density (e_n)	$f = 1\text{kHz}$, $V_{CM} = V_S/2$	80			$\text{nV}/\sqrt{\text{Hz}}$	TYP	
	$f = 10\text{kHz}$, $V_{CM} = V_S/2$	36					

ELECTRICAL CHARACTERISTICS (continued)

(At $T_A = +25^\circ\text{C}$, $V_S = 15\text{V}$, $R_L = 2\text{k}\Omega$ connected to $V_S/2$, $V_{OUT} = V_S/2$, unless otherwise noted.)

PARAMETER	CONDITIONS	SGM8425/6/8					
		TYP	MIN/MAX OVER TEMPERATURE			UNITS	MIN/MAX
		+25°C	+25°C	-40°C to +85°C			
Input Characteristics							
Input Offset Voltage (V_{OS})	$V_{CM} = V_S/2$	1.0	6.5	7.4	mV	MAX	
Input Offset Voltage Drift ($\Delta V_{OS}/\Delta T$)		4.9			$\mu\text{V}/^\circ\text{C}$	TYP	
Input Common Mode Voltage Range (V_{CM})		-0.1 to 15.1			V	TYP	
Common Mode Rejection Ratio (CMRR)	$V_{CM} = -0.1\text{V to } 15.1\text{V}$	71	57	55	dB	MIN	
Open-Loop Voltage Gain (A_{OL})	$V_{OUT} = 0.5\text{V to } 14.5\text{V}$	92	80	75	dB	MIN	
Output Characteristics							
Output Voltage Swing from Rail	V_{OH} $I_{OUT} = 5\text{mA}$	84	133	164	mV	MAX	
	V_{OL} $I_{OUT} = -5\text{mA}$	84	121	181	mV	MAX	
Transient Peak Output Current (I_{PK})	Sink $V_S = 19\text{V}$	336			mA	TYP	
	Source $V_S = 19\text{V}$	227					
Output Current (I_{OUT})		80			mA	TYP	
Power Supply							
Quiescent Current/Amplifier (I_Q)	$I_{OUT} = 0\text{A}$	1.6	2.2	3.4	mA	MAX	
Dynamic Performance							
Gain-Bandwidth Product (GBP)	$R_L = 10\text{k}\Omega$, $C_L = 10\text{pF}$, $V_{CM} = V_S/2$	9			MHz	TYP	
-3dB Bandwidth (BW)	$R_L = 10\text{k}\Omega$, $C_L = 10\text{pF}$, $V_{CM} = V_S/2$	18			MHz	TYP	
Slew Rate (SR)	$V_{OUT} = 2V_{PP}$ step, $A_V = 1$	14			$\text{V}/\mu\text{s}$	TYP	
Phase Margin	$R_L = 10\text{k}\Omega$, $C_L = 10\text{pF}$, $V_{CM} = V_S/2$	35			$^\circ$	TYP	
Gain Margin	$R_L = 10\text{k}\Omega$, $C_L = 10\text{pF}$, $V_{CM} = V_S/2$	-5			dB	TYP	
Crosstalk	$f = 5\text{MHz}$	77			dB	TYP	
Settling Time (t_s)	$V_{OUT} = 2V_{PP}$ step, $A_V = 1$	0.34			μs	TYP	
Noise Performance							
Input Voltage Noise Density (e_n)	$f = 1\text{kHz}$, $V_{CM} = V_S/2$	79			$\text{nV}/\sqrt{\text{Hz}}$	V	
	$f = 10\text{kHz}$, $V_{CM} = V_S/2$	35					

ELECTRICAL CHARACTERISTICS (continued)

(At $T_A = +25^\circ\text{C}$, $V_S = \pm 15\text{V}$, $R_L = 2\text{k}\Omega$ connected to 0V , $V_{OUT} = 0\text{V}$, unless otherwise noted.)

PARAMETER	CONDITIONS	SGM8425/6/8					
		TYP	MIN/MAX OVER TEMPERATURE			UNITS	MIN/ MAX
		+25°C	+25°C	-40°C to +85°C			
Input Characteristics							
Input Offset Voltage (V_{OS})	$V_{CM} = 0\text{V}$	1.0	6.5	7.3	mV	MAX	
Input Offset Voltage Drift ($\Delta V_{OS}/\Delta T$)		4.9			$\mu\text{V}/^\circ\text{C}$	TYP	
Input Common Mode Voltage Range (V_{CM})		-15.1 to 15.1			V	TYP	
Common Mode Rejection Ratio (CMRR)	$V_{CM} = -15.1\text{V}$ to 15.1V	77	63	60	dB	MIN	
Large-Signal Voltage Gain (A_{VO})	$V_{OUT} = -14.5\text{V}$ to 14.5V	95	84	80	dB	MIN	
Output Characteristics							
Output Voltage Swing from Rail	V_{OH} $I_{OUT} = 5\text{mA}$	94	151	192	mV	MAX	
	V_{OL} $I_{OUT} = -5\text{mA}$	97	135	202	mV	MAX	
Output Current (I_{OUT})		80			mA	TYP	
Power Supply							
Quiescent Current/Amplifier (I_Q)	$I_{OUT} = 0\text{A}$	1.6	2.3	3.5	mA	MAX	
Dynamic Performance							
Gain-Bandwidth Product (GBP)	$R_L = 10\text{k}\Omega$, $C_L = 10\text{pF}$, $V_{CM} = 0\text{V}$	9			MHz	TYP	
-3dB Bandwidth (BW)	$R_L = 10\text{k}\Omega$, $C_L = 10\text{pF}$, $V_{CM} = 0\text{V}$	19			MHz	TYP	
Slew Rate (SR)	$V_{OUT} = 2V_{PP}$ step, $A_V = 1$	16			$\text{V}/\mu\text{s}$	TYP	
Phase Margin	$R_L = 10\text{k}\Omega$, $C_L = 10\text{pF}$, $V_{CM} = 0\text{V}$	35			$^\circ$	TYP	
Gain Margin	$R_L = 10\text{k}\Omega$, $C_L = 10\text{pF}$, $V_{CM} = 0\text{V}$	-5			dB	TYP	
Crosstalk	$f = 5\text{MHz}$	78			dB	TYP	
Settling Time (t_s)	$V_{OUT} = 2V_{PP}$ step, $A_V = 1$	0.36			μs	TYP	
Noise Performance							
Input Voltage Noise Density (e_n)	$f = 1\text{kHz}$, $V_{CM} = 0\text{V}$	75			$\text{nV}/\sqrt{\text{Hz}}$	TYP	
	$f = 10\text{kHz}$, $V_{CM} = 0\text{V}$	34					

TYPICAL PERFORMANCE CHARACTERISTICS

At $T_A = +25^\circ\text{C}$, $V_S = 15\text{V}$, $V_{CM} = V_S/2$, $R_L = 2\text{k}\Omega$ connected to $V_S/2$, $V_{OUT} = V_S/2$, unless otherwise noted.

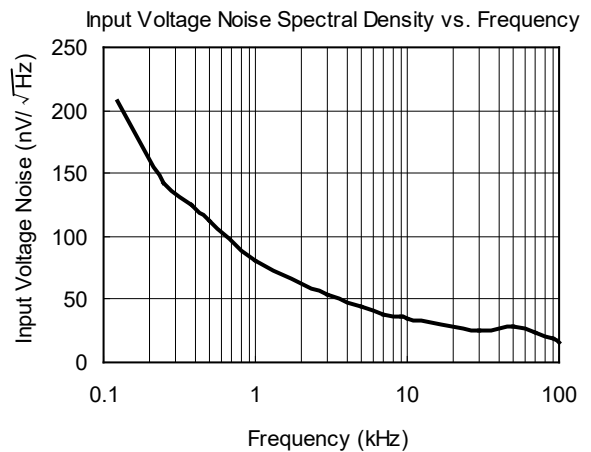
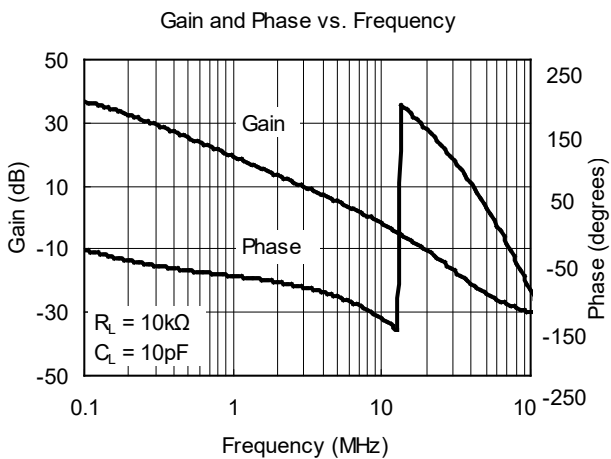
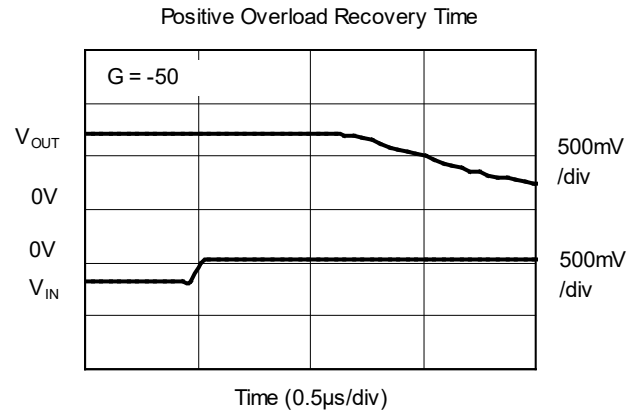
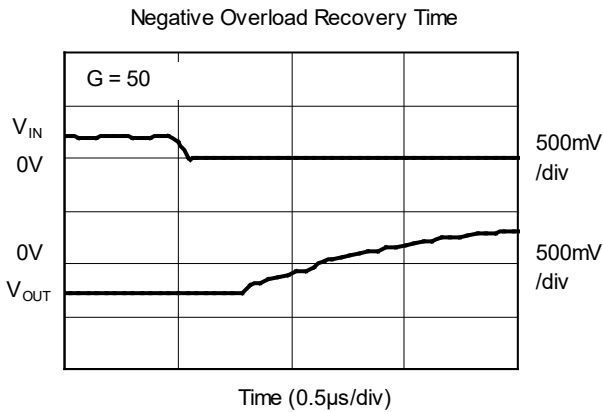
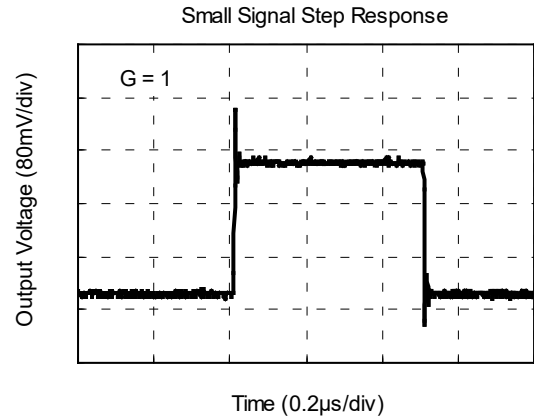
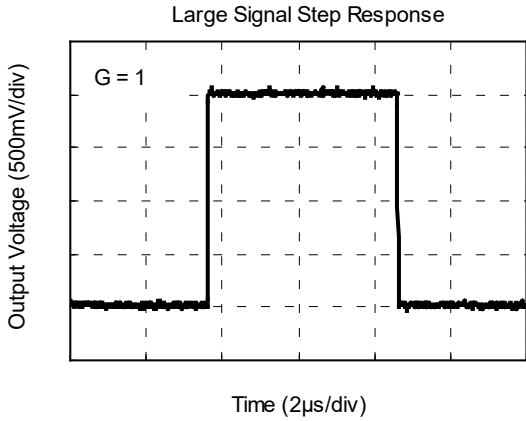

TYPICAL PERFORMANCE CHARACTERISTICS (continued)

At $T_A = +25^\circ\text{C}$, $V_S = 15\text{V}$, $V_{CM} = V_S/2$, $R_L = 2\text{k}\Omega$ connected to $V_S/2$, $V_{OUT} = V_S/2$, unless otherwise noted.

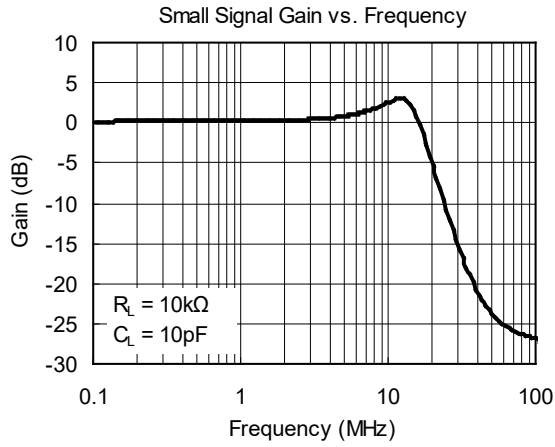

REVISION HISTORY

NOTE: Page numbers for previous revisions may differ from page numbers in the current version.

JUNE 2013 – REV.A to REV.A.1	Page
Added SGM8425AYN5G package.....	All

Changes from Original (DECEMBER 2012) to REV.A	Page
Changed from product preview to production data.....	All

PACKAGE OUTLINE DIMENSIONS

SOT-23-5

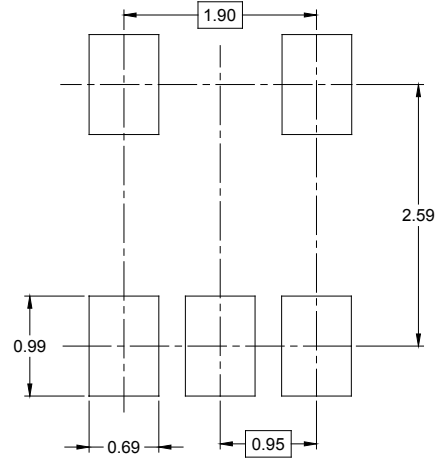
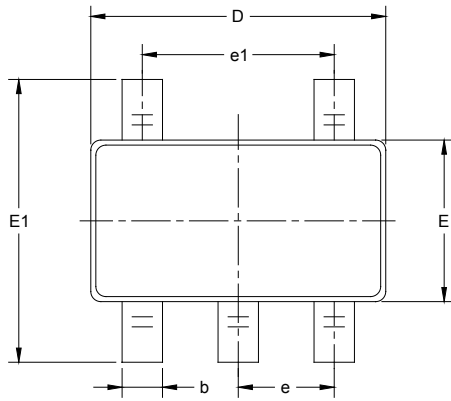

RECOMMENDED LAND PATTERN (Unit: mm)

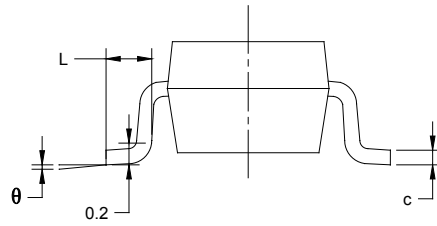
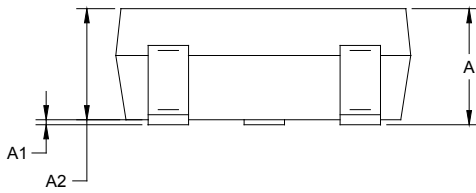

Symbol	Dimensions In Millimeters		Dimensions In Inches	
	MIN	MAX	MIN	MAX
A	1.050	1.250	0.041	0.049
A1	0.000	0.100	0.000	0.004
A2	1.050	1.150	0.041	0.045
b	0.300	0.500	0.012	0.020
c	0.100	0.200	0.004	0.008
D	2.820	3.020	0.111	0.119
E	1.500	1.700	0.059	0.067
E1	2.650	2.950	0.104	0.116
e	0.950 BSC		0.037 BSC	
e1	1.900 BSC		0.075 BSC	
L	0.300	0.600	0.012	0.024
θ	0°	8°	0°	8°

PACKAGE OUTLINE DIMENSIONS

SOIC-8

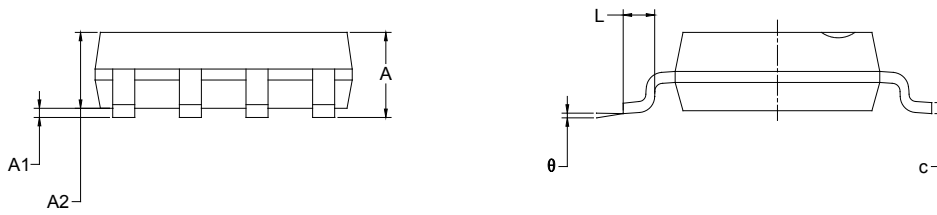
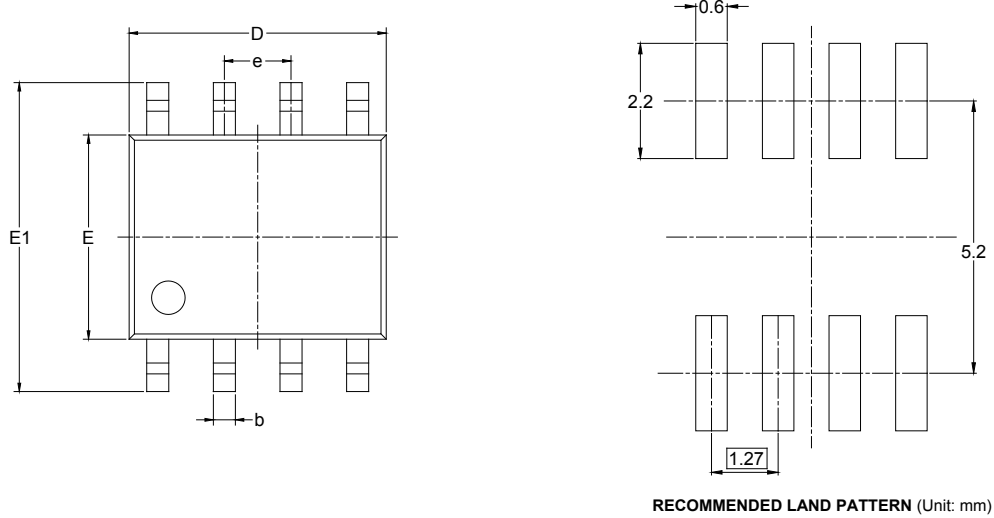

Symbol	Dimensions In Millimeters		Dimensions In Inches	
	MIN	MAX	MIN	MAX
A	1.350	1.750	0.053	0.069
A1	0.100	0.250	0.004	0.010
A2	1.350	1.550	0.053	0.061
b	0.330	0.510	0.013	0.020
c	0.170	0.250	0.006	0.010
D	4.700	5.100	0.185	0.200
E	3.800	4.000	0.150	0.157
E1	5.800	6.200	0.228	0.244
e	1.27 BSC		0.050 BSC	
L	0.400	1.270	0.016	0.050
θ	0°	8°	0°	8°

PACKAGE OUTLINE DIMENSIONS

MSOP-8

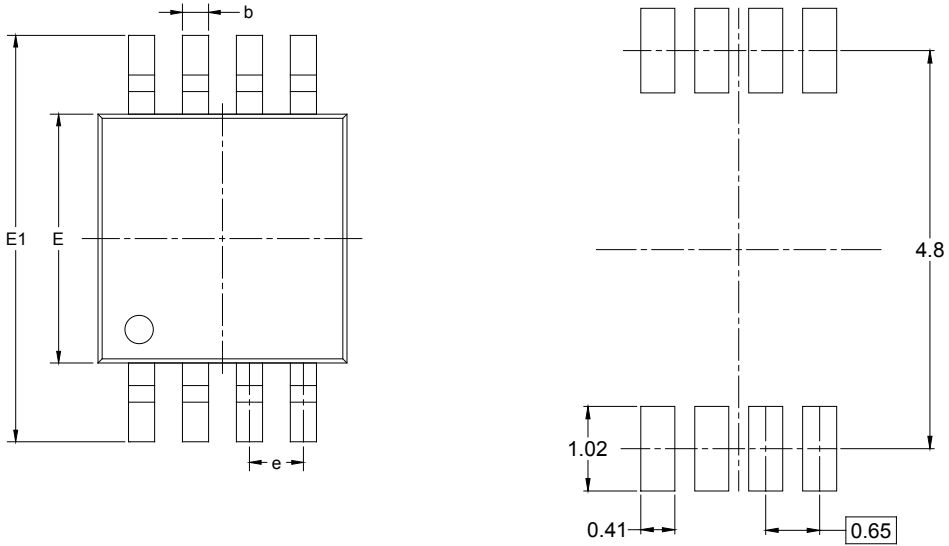

RECOMMENDED LAND PATTERN (Unit: mm)

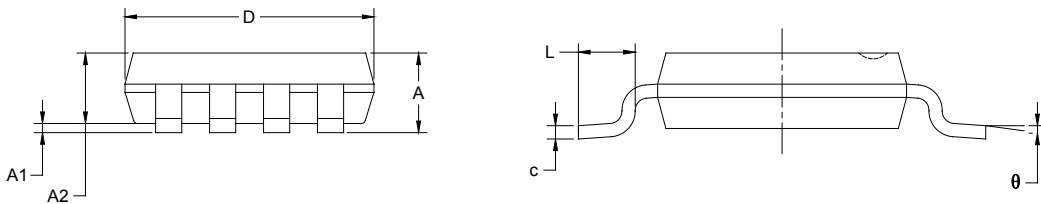

Symbol	Dimensions In Millimeters		Dimensions In Inches	
	MIN	MAX	MIN	MAX
A	0.820	1.100	0.032	0.043
A1	0.020	0.150	0.001	0.006
A2	0.750	0.950	0.030	0.037
b	0.250	0.380	0.010	0.015
c	0.090	0.230	0.004	0.009
D	2.900	3.100	0.114	0.122
E	2.900	3.100	0.114	0.122
E1	4.750	5.050	0.187	0.199
e	0.650 BSC		0.026 BSC	
L	0.400	0.800	0.016	0.031
θ	0°	6°	0°	6°

PACKAGE INFORMATION

PACKAGE OUTLINE DIMENSIONS

SOIC-14

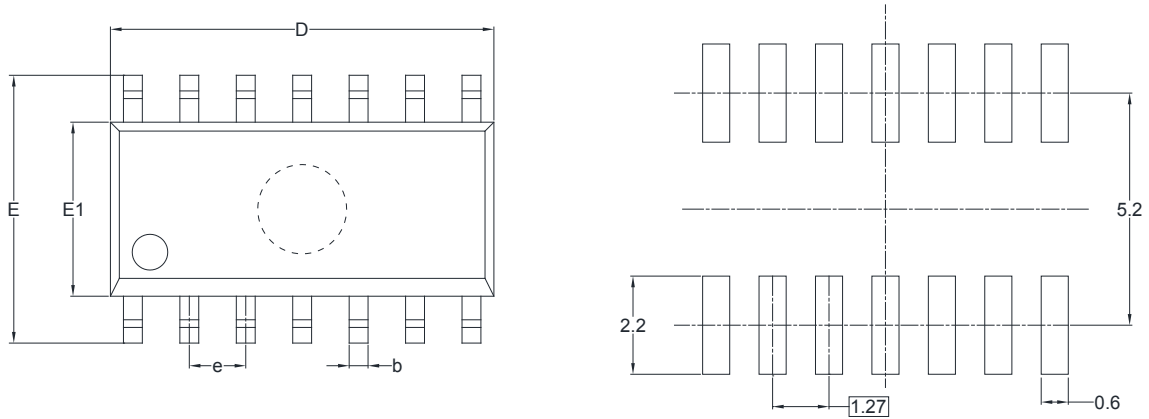

RECOMMENDED LAND PATTERN (Unit: mm)

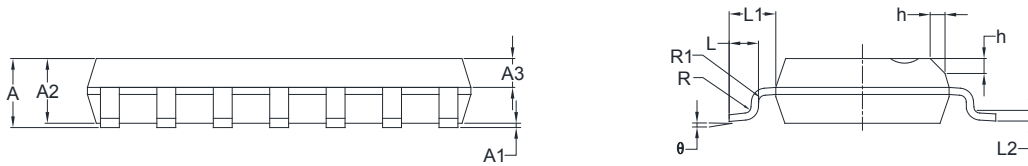

Symbol	Dimensions In Millimeters		Dimensions In Inches	
	MIN	MAX	MIN	MAX
A	1.35	1.75	0.053	0.069
A1	0.10	0.25	0.004	0.010
A2	1.25	1.65	0.049	0.065
A3	0.55	0.75	0.022	0.030
b	0.36	0.49	0.014	0.019
D	8.53	8.73	0.336	0.344
E	5.80	6.20	0.228	0.244
E1	3.80	4.00	0.150	0.157
e	1.27 BSC		0.050 BSC	
L	0.45	0.80	0.018	0.032
L1	1.04 REF		0.040 REF	
L2	0.25 BSC		0.01 BSC	
R	0.07		0.003	
R1	0.07		0.003	
h	0.30	0.50	0.012	0.020
θ	0°	8°	0°	8°

PACKAGE OUTLINE DIMENSIONS

TSSOP-14

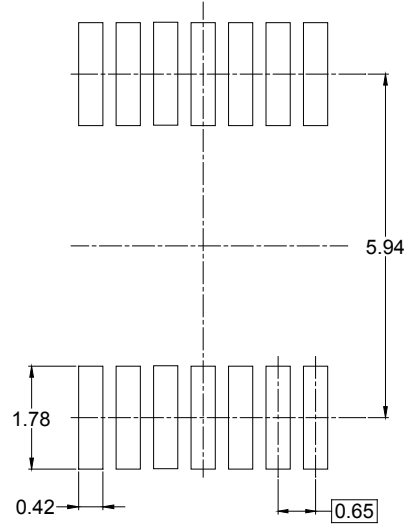
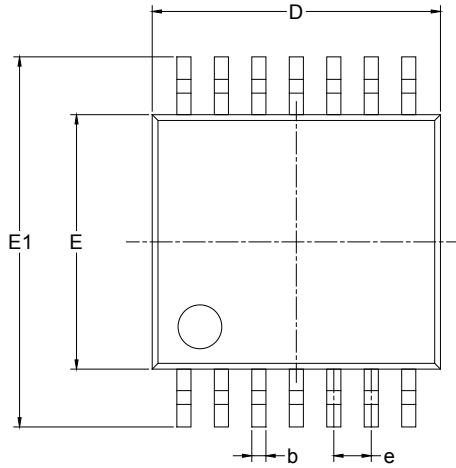

RECOMMENDED LAND PATTERN (Unit: mm)

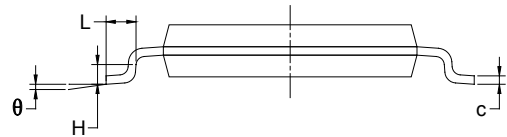
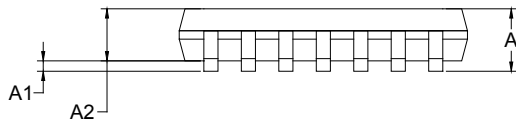

Symbol	Dimensions In Millimeters		Dimensions In Inches	
	MIN	MAX	MIN	MAX
A		1.200		0.047
A1	0.050	0.150	0.002	0.006
A2	0.800	1.050	0.031	0.041
b	0.190	0.300	0.007	0.012
c	0.090	0.200	0.004	0.008
D	4.860	5.100	0.191	0.201
E	4.300	4.500	0.169	0.177
E1	6.250	6.550	0.246	0.258
e	0.650 BSC		0.026 BSC	
L	0.500	0.700	0.02	0.028
H	0.25 TYP		0.01 TYP	
θ	1°	7°	1°	7°

PACKAGE INFORMATION

TAPE AND REEL INFORMATION

REEL DIMENSIONS



TAPE DIMENSIONS



NOTE: The picture is only for reference. Please make the object as the standard.

KEY PARAMETER LIST OF TAPE AND REEL

Package Type	Reel Diameter	Reel Width W1 (mm)	A0 (mm)	B0 (mm)	K0 (mm)	P0 (mm)	P1 (mm)	P2 (mm)	W (mm)	Pin1 Quadrant
SOT-23-5	7"	9.5	3.20	3.20	1.40	4.0	4.0	2.0	8.0	Q3
SOIC-8	13"	12.4	6.40	5.40	2.10	4.0	8.0	2.0	12.0	Q1
MSOP-8	13"	12.4	5.20	3.30	1.50	4.0	8.0	2.0	12.0	Q1
SOIC-14	13"	16.4	6.60	9.30	2.10	4.0	8.0	2.0	16.0	Q1
TSSOP-14	13"	12.4	6.95	5.60	1.20	4.0	8.0	2.0	12.0	Q1

D20001

PACKAGE INFORMATION

CARTON BOX DIMENSIONS



NOTE: The picture is only for reference. Please make the object as the standard.

KEY PARAMETER LIST OF CARTON BOX

Reel Type	Length (mm)	Width (mm)	Height (mm)	Pizza/Carton
7" (Option)	368	227	224	8
7"	442	410	224	18
13"	386	280	370	5

DD0002