



SGM8417-1/SGM8417-2/SGM8417-4 24V, 1.5A Peak Output Current Rail-to-Rail I/O Operational Amplifiers

GENERAL DESCRIPTION

The SGM8417-1(single), SGM8417-2 (dual) and SGM8417-4 (quad) are high slew rate, low power operational amplifiers optimized for high voltage systems. These devices can operate on single or dual power supply. They support rail-to-rail input and output operation.

The SGM8417-1/2/4 feature 10mV maximum offset voltage, 1.5A peak output current, and 65V/ μ s high slew rate. The combination of characteristics makes them suitable for TFT-LCDs.

The SGM8417-1 is available in a Green TDFN-3 \times 3-8L package. The SGM8417-2 is available in a Green MSOP-8 (Exposed Pad) package. The SGM8417-4 is available in a Green TSSOP-14 (Exposed Pad) package. They are specified over the -40°C to +85°C temperature range.

FEATURES

- **Peak Output Current: 1.5A**
- **High Slew Rate: 65V/ μ s**
- **Unity-Gain Stable**
- **Rail-to-Rail Input and Output**
- **Supply Voltage Range: 4.5V to 26.5V**
- **-40°C to +85°C Operating Temperature Range**
- **Small Packaging:**
 - SGM8417-1 Available in a Green TDFN-3 \times 3-8L Package**
 - SGM8417-2 Available in a Green MSOP-8 (Exposed Pad) Package**
 - SGM8417-4 Available in a Green TSSOP-14 (Exposed Pad) Package**

APPLICATIONS

TFT-LCD Panels
LCD TVs
Monitors
Laptops

PACKAGE/ORDERING INFORMATION

MODEL	PACKAGE DESCRIPTION	SPECIFIED TEMPERATURE RANGE	ORDERING NUMBER	PACKAGE MARKING	PACKING OPTION
SGM8417-1	TDFN-3x3-8L	-40°C to +85°C	SGM8417-1YTDB8G/TR	SGM G61DB XXXXX	Tape and Reel, 4000
SGM8417-2	MSOP-8 (Exposed Pad)	-40°C to +85°C	SGM8417-2YPMS8G/TR	SGM84172 YPMS8 XXXXX	Tape and Reel, 4000
SGM8417-4	TSSOP-14 (Exposed Pad)	-40°C to +85°C	SGM8417-4YPTS14G/TR	SGM84174 YPTS14 XXXXX	Tape and Reel, 4000

MARKING INFORMATION

NOTE: XXXXX = Date Code and Vendor Code.

XXXXX

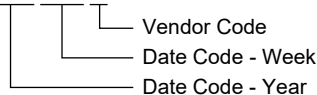

Green (RoHS & HSF): SG Micro Corp defines "Green" to mean Pb-Free (RoHS compatible) and free of halogen substances. If you have additional comments or questions, please contact your SGMICRO representative directly.

ABSOLUTE MAXIMUM RATINGS

- Supply Voltage, +V_S to -V_S..... -0.3V to 28V
- Input/Output Voltage to -V_S..... -0.3V to (+V_S) + 0.3V
- +IN to -IN ±5V
- Package Thermal Resistance
- TDFN-3x3-8L, θ_{JA}..... 84°C/W
- MSOP-8 (Exposed Pad), θ_{JA}..... 82°C/W
- TSSOP-14 (Exposed Pad), θ_{JA}..... 50°C/W
- Junction Temperature..... +150°C
- Storage Temperature Range -65°C to +150°C
- Lead Temperature (Soldering, 10s)..... +260°C
- ESD Susceptibility
- HBM..... 8000V
- MM..... 300V
- CDM 1000V

RECOMMENDED OPERATING CONDITIONS

- Supply Voltage Range4.5V to 26.5V
- Operating Temperature Range-40°C to +85°C

OVERSTRESS CAUTION

Stresses beyond those listed in Absolute Maximum Ratings may cause permanent damage to the device. Exposure to absolute maximum rating conditions for extended periods may affect reliability. Functional operation of the device at any conditions beyond those indicated in the Recommended Operating Conditions section is not implied.

ESD SENSITIVITY CAUTION

This integrated circuit can be damaged if ESD protections are not considered carefully. SGMICRO recommends that all integrated circuits be handled with appropriate precautions. Failure to observe proper handling and installation procedures can cause damage. ESD damage can range from subtle performance degradation to complete device failure. Precision integrated circuits may be more susceptible to damage because even small parametric changes could cause the device not to meet the published specifications.

DISCLAIMER

SG Micro Corp reserves the right to make any change in circuit design, or specifications without prior notice.

PIN CONFIGURATIONS

FUNCTIONAL BLOCK DIAGRAMS

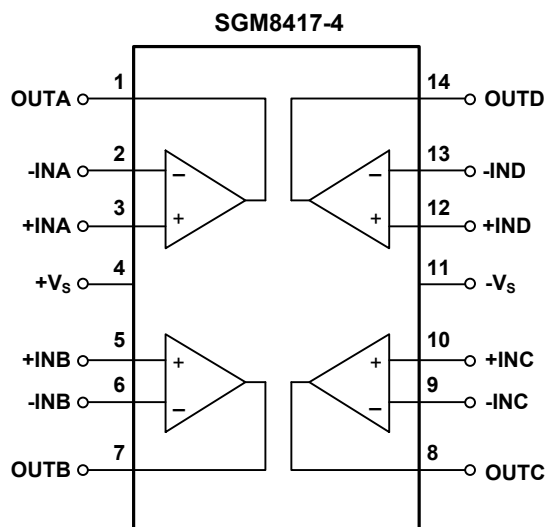
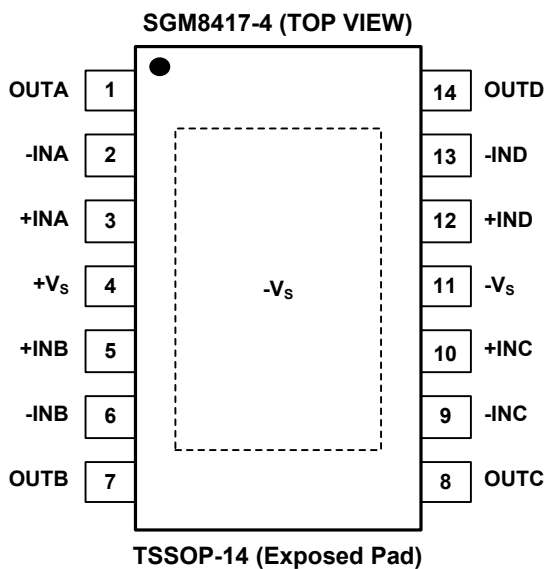
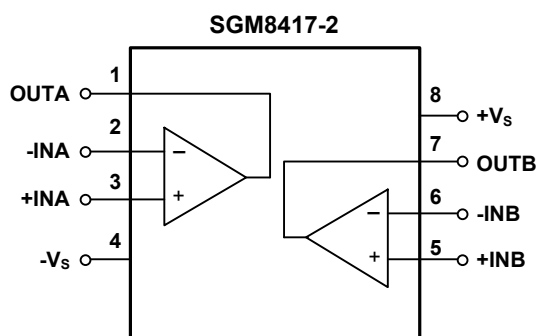
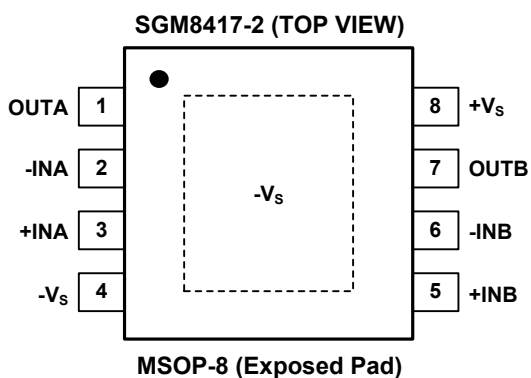
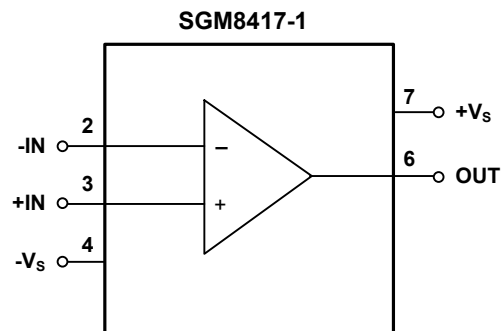
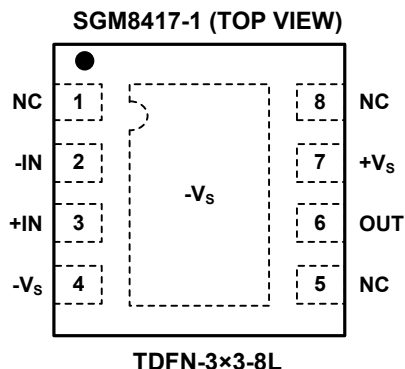

NOTE: For all packages, connect thermal die pad to $-V_s$. Connect it to $-V_s$ plane to maximize thermal performance.

ELECTRICAL CHARACTERISTICS

(+V_S = 16V, -V_S = 0V, +V_{IN} = V_{OUT} = +V_S/2, typical values are at T_A = +25°C, unless otherwise specified.)

PARAMETER	SYMBOL	CONDITIONS	MIN	TYP	MAX	UNITS
Input Characteristics						
Input Offset Voltage	V _{OS}	V _{CM} = +V _S /2		2	10	mV
Input Offset Voltage Drift	ΔV _{OS} /ΔT	V _{CM} = +V _S /2		3.6		μV/°C
Input Bias Current	I _B	V _{CM} = +V _S /2		1		nA
Load Regulation	ΔV _{LOAD}	I _{OUT} = 0mA to -80mA		0.01		mV/mA
		I _{OUT} = 0mA to 80mA		-0.01		
Input Common Mode Voltage Range	V _{CM}		-0.1		(+V _S) + 0.1	V
Common Mode Rejection Ratio	CMRR	-0.1V ≤ V _{CM} ≤ (+V _S) + 0.1V		72		dB
Open-Loop Voltage Gain	A _{OL}	0.5V ≤ V _{OUT} ≤ (+V _S) - 0.5V		120		dB
Output Characteristics						
Low Output Voltage Swing from Rail	V _{OL}	I _L = -50mA		0.13	0.18	V
High Output Voltage Swing from Rail	V _{OH}	I _L = 50mA	(+V _S) - 0.28	(+V _S) - 0.21		V
Transient Peak Output Current	I _{PK}			±1.5		A
Continuous Output Current	I _{OUT}			±400		mA
Power Supply						
Supply Voltage Range			4.5		26.5	V
Power Supply Rejection Ratio	PSRR	+V _S = 4.5V to 26.5V, V _{CM} = 3V		94		dB
Quiescent Current/Amplifier	I _Q	No load		3.3		mA
Dynamic Performance						
Slew Rate	SR	4V step, C _L = 50pF, R _L = 10kΩ, 20% to 80%, A _V = 1		65		V/μs
Settling Time to ±0.1%	t _s	A _V = 1, V _{OUT} = 2V step, R _L = 10kΩ, C _L = 10pF		140		ns
-3dB Bandwidth	BW	R _L = 10kΩ, C _L = 10pF		68		MHz
Gain-Bandwidth Product	GBP	R _L = 10kΩ, C _L = 10pF		28		MHz
Phase Margin		R _L = 10kΩ, C _L = 10pF		30		°
Noise Performance						
Input Voltage Noise Density	e _n	f = 1kHz		115		nV/√Hz
Thermal Protection						
Thermal Shutdown Temperature	T _{SHDN}			150		°C
Thermal Shutdown Hysteresis	ΔT _{SHDN}			25		°C

TYPICAL PERFORMANCE CHARACTERISTICS

At $T_A = +25^\circ\text{C}$, $+V_S = 16\text{V}$, $-V_S = 0\text{V}$, unless otherwise specified.

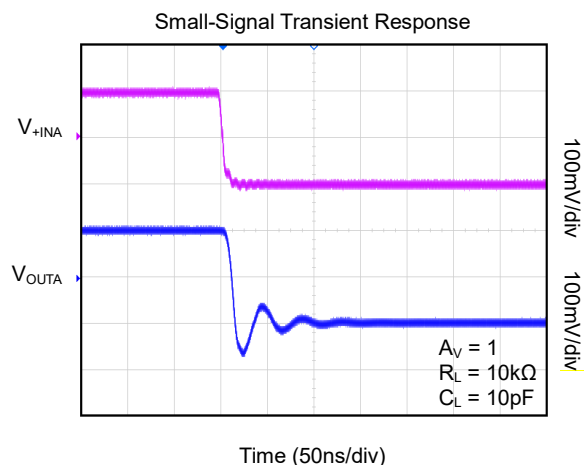
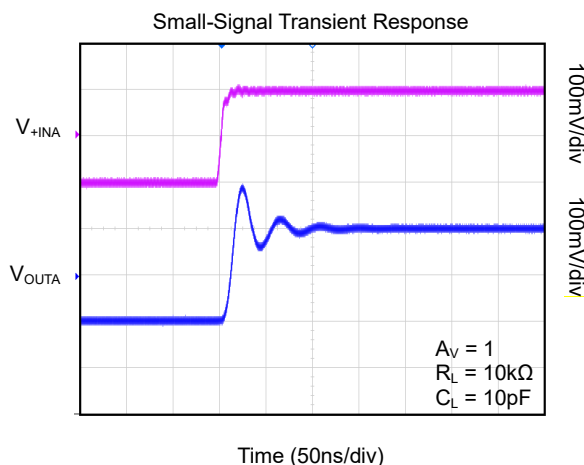
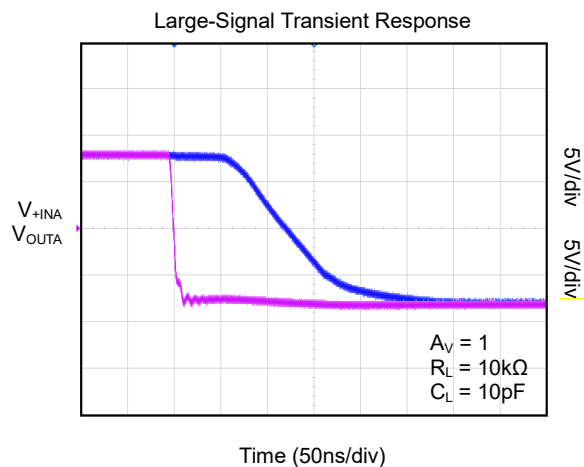
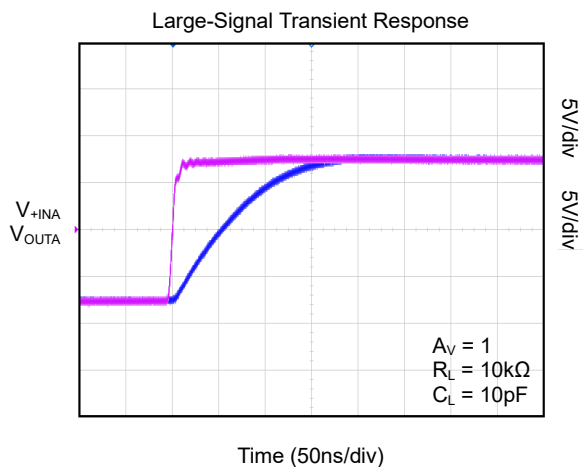

APPLICATION INFORMATION

The SGM8417-1/2/4 are specifically designed to drive high current load. These devices support rail-to-rail input and output operation, and consume low quiescent current. They can also provide a high slew rate. The combination of characteristics makes SGM8417-1/2/4 suitable for LCD applications.

Operating Voltage

The SGM8417-1/2/4 are guaranteed to operate from 4.5V to 26.5V, and the operation is extremely stable over the whole specified range of the temperature. The output voltage swing can be closer to the supply rail by reducing the load current.

LCD Panel Application

The SGM8417-1/2/4 can provide optimal performance in LCD V_{COM} buffer. They feature $\pm 1.5A$ transient peak source/sink current.

Output Current Limit

The SGM8417-1/2/4 can drive $\pm 1.5A$ transient peak output current. These devices have a $\pm 1.5A$ (TYP) current limit, which is accomplished with the characteristics of the internal metal interconnects. Maximum reliability is maintained if the output continuous current never exceeds $\pm 400mA$.

Thermal Consideration

When operating the devices, the users need to make sure that the junction temperature is below the absolute maximum one. The junction temperature is increasing because the power dissipation is higher than before. And a lot of possibilities can cause the thermal considerations, such as the width of trace in PCB, the package of the devices, the gap between ambient and junction temperature and rate of environmental airflow.

The following equation indicates the calculation of power dissipation:

$$P_{D(MAX)} = (T_{J(MAX)} - T_A) / \theta_{JA} \quad (1)$$

where:

$T_{J(MAX)}$ = Maximum junction temperature.

T_A = Ambient temperature.

θ_{JA} = Junction to ambient thermal resistance.

It is recommended that the junction temperature should not exceed $+125^\circ C$ for normal operation. The parameter of ambient thermal resistance is determined by the width of trace in PCB layout.

In addition, the ambient temperature and thermal resistance will affect the power dissipation of SGM8417-1/2/4.

Layout

For the circuits with high power path, a good PCB design is essential. It is recommended to use the following layout method to improve the performance of SGM8417-1/2/4 at most.

- ◆ The power component should be close enough to SGM8417-1/2/4 for better performance. Also, if the high current is necessary, the corresponding trace in PCB should be short and wide.

- ◆ For some applications such as filtering, a series resistor is necessary to be added at the output of the devices.

- ◆ Choosing a suitable bypass capacitor can enhance the stability when driving the loads with high transient. For single-supply operation, the bypass capacitor should be placed as close to $+V_S$ pin as possible. For dual-supply operation, both $+V_S$ and $-V_S$ supplies should be bypassed to ground with separate $0.1\mu F$ ceramic capacitors. Using a $10\mu F$ tantalum capacitor is a good choice to improve the operating stability of the devices when driving high transient load.

- ◆ A $0.1\mu F$ capacitor should be connected with $+IN$ pin to GND for better operation of SGM8417-1/2/4 and the distance between this capacitor and $+IN$ pin should be minimized.

- ◆ It is recommended to connect exposed pad to $-V_S$ directly in the PCB.

REVISION HISTORY

NOTE: Page numbers for previous revisions may differ from page numbers in the current version.

JULY 2020 – REV.A to REV.A.1

Page

Updated TSSOP-14 (Exposed Pad) package	10
Updated Tape and Reel Information section	11

Changes from Original (MAY 2016) to REV.A

Page

Changed from product preview to production data	All
---	-----

PACKAGE OUTLINE DIMENSIONS

TDFN-3x3-8L

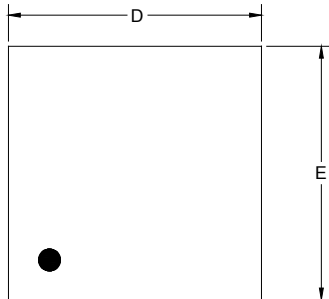

TOP VIEW

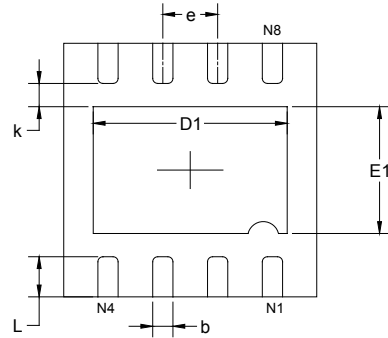

BOTTOM VIEW

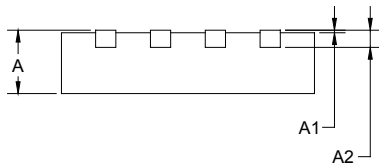

SIDE VIEW

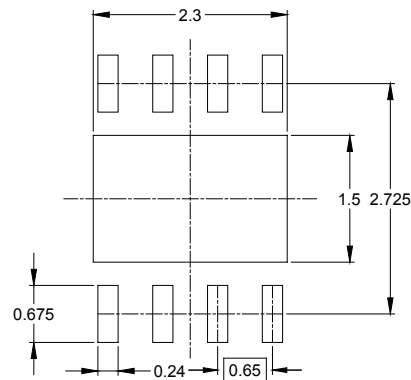

RECOMMENDED LAND PATTERN (Unit: mm)

Symbol	Dimensions In Millimeters		Dimensions In Inches	
	MIN	MAX	MIN	MAX
A	0.700	0.800	0.028	0.031
A1	0.000	0.050	0.000	0.002
A2	0.203 REF		0.008 REF	
D	2.900	3.100	0.114	0.122
D1	2.200	2.400	0.087	0.094
E	2.900	3.100	0.114	0.122
E1	1.400	1.600	0.055	0.063
k	0.200 MIN		0.008 MIN	
b	0.180	0.300	0.007	0.012
e	0.650 TYP		0.026 TYP	
L	0.375	0.575	0.015	0.023

PACKAGE OUTLINE DIMENSIONS

MSOP-8 (Exposed Pad)

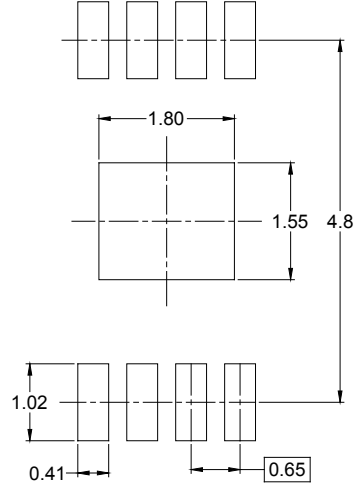
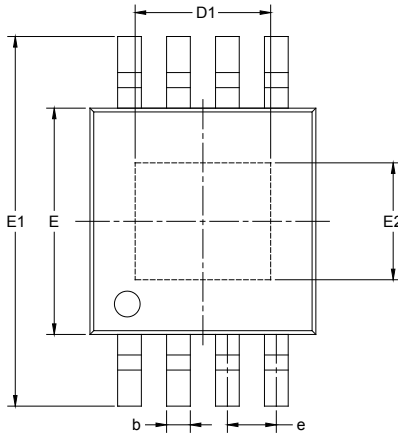

RECOMMENDED LAND PATTERN (Unit: mm)

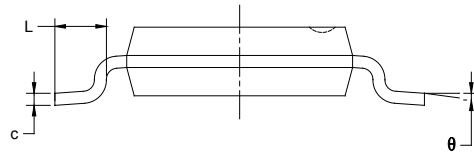
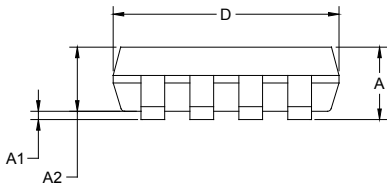

Symbol	Dimensions In Millimeters		Dimensions In Inches	
	MIN	MAX	MIN	MAX
A	0.820	1.100	0.032	0.043
A1	0.020	0.150	0.001	0.006
A2	0.750	0.950	0.030	0.037
b	0.250	0.380	0.010	0.015
c	0.090	0.230	0.004	0.009
D	2.900	3.100	0.114	0.122
D1	1.700	1.900	0.067	0.075
e	0.65 BSC		0.026 BSC	
E	2.900	3.100	0.114	0.122
E1	4.750	5.050	0.187	0.199
E2	1.450	1.650	0.057	0.065
L	0.400	0.800	0.016	0.031
θ	0°	6°	0°	6°

PACKAGE OUTLINE DIMENSIONS

TSSOP-14 (Exposed Pad)

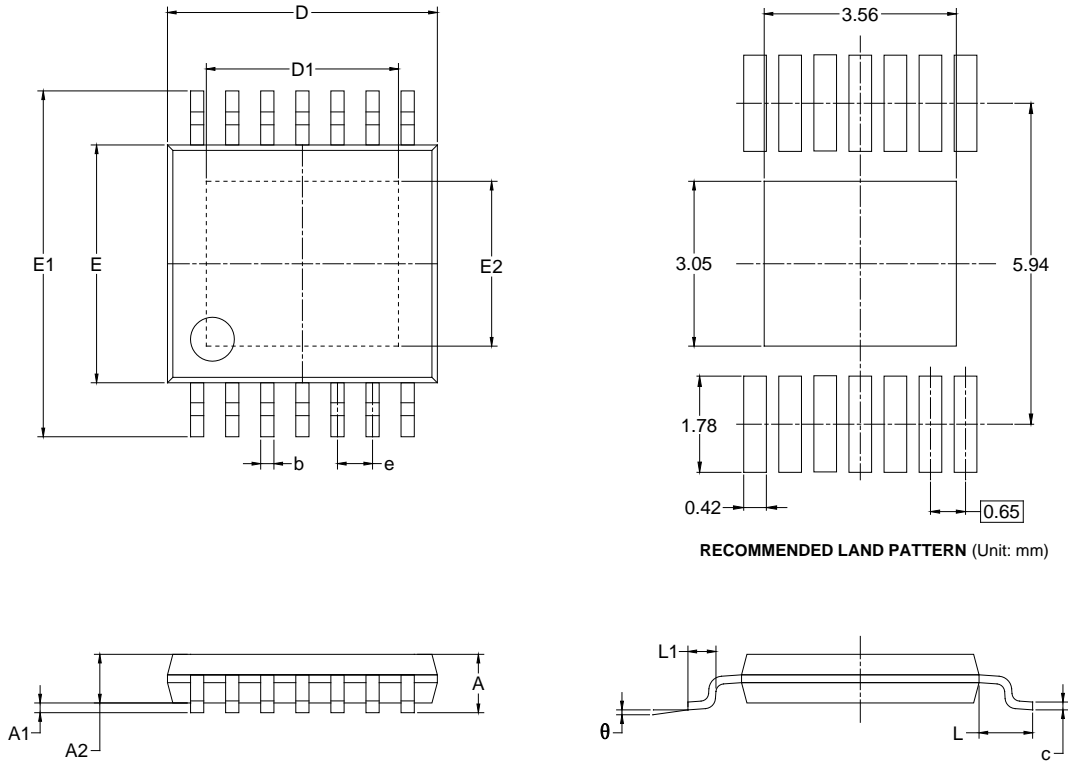

Symbol	Dimensions In Millimeters		Dimensions In Inches	
	MIN	MAX	MIN	MAX
A		1.200		0.047
A1	0.050	0.150	0.002	0.006
A2	0.800	1.050	0.031	0.041
b	0.190	0.300	0.007	0.012
c	0.090	0.200	0.004	0.008
D	4.900	5.100	0.193	0.201
D1	3.460	3.660	0.136	0.144
E	4.300	4.500	0.169	0.177
E1	6.250	6.550	0.246	0.258
E2	2.950	3.150	0.116	0.124
e	0.650 BSC		0.026 BSC	
L		1.000		0.039
L1	0.450	0.750	0.018	0.030
θ	0°	8°	0°	8°

PACKAGE INFORMATION

TAPE AND REEL INFORMATION

REEL DIMENSIONS

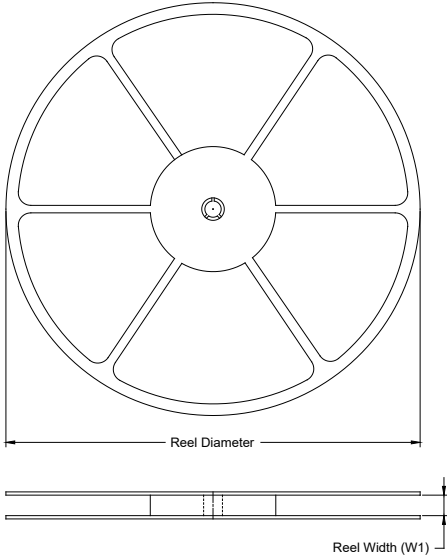

TAPE DIMENSIONS



NOTE: The picture is only for reference. Please make the object as the standard.

KEY PARAMETER LIST OF TAPE AND REEL

Package Type	Reel Diameter	Reel Width W1 (mm)	A0 (mm)	B0 (mm)	K0 (mm)	P0 (mm)	P1 (mm)	P2 (mm)	W (mm)	Pin1 Quadrant
TDFN-3×3-8L	13"	12.4	3.35	3.35	1.13	4.0	8.0	2.0	12.0	Q1
MSOP-8 (Exposed Pad)	13"	12.4	5.20	3.30	1.50	4.0	8.0	2.0	12.0	Q1
TSSOP-14 (Exposed Pad)	13"	16.4	6.80	5.40	1.30	4.0	8.0	2.0	16.0	Q1

DD0001

PACKAGE INFORMATION

CARTON BOX DIMENSIONS



NOTE: The picture is only for reference. Please make the object as the standard.

KEY PARAMETER LIST OF CARTON BOX

Reel Type	Length (mm)	Width (mm)	Height (mm)	Pizza/Carton
13"	386	280	370	5

DD0002