



SGM8545

1.1MHz, 48 μ A, Rail-to-Rail I/O CMOS Operational Amplifier

GENERAL DESCRIPTION

The SGM8545 (single) is a low cost, voltage feedback amplifier. The device can operate from 2.1V to 5.5V single supply, while consuming only 48 μ A quiescent current. It provides rail-to-rail input with a wide input common mode voltage range and rail-to-rail output voltage swing. This feature makes SGM8545 appropriate for buffering ASIC.

The SGM8545 offers a gain-bandwidth product of 1.1MHz and an ultra-low input bias current of 0.5pA. It is well suited for piezoelectric sensors, integrators and photodiode amplifiers.

The SGM8545 is designed into a wide range of applications, such as battery-powered instrumentation, safety monitoring, portable systems, and transducer interface circuits in low power systems.

The SGM8545 is available in a Green SOT-23-5 package. It is specified over the extended -40 $^{\circ}$ C to +125 $^{\circ}$ C temperature range.

FEATURES

- **Low Cost**
- **Input Offset Voltage: 3.5mV (MAX)**
- **Ultra-Low Input Bias Current: 0.5pA**
- **Unity-Gain Stable**
- **Gain-Bandwidth Product: 1.1MHz**
- **Rail-to-Rail Input and Output**
- **Supply Voltage Range: 2.1V to 5.5V**
- **Input Voltage Range:**
 - 0.1V to 5.6V with $V_S = 5.5V$
- **Low Supply Current: 48 μ A**
- **-40 $^{\circ}$ C to +125 $^{\circ}$ C Operating Temperature Range**
- **Available in a Green SOT-23-5 Package**

APPLICATIONS

ASIC Input or Output Amplifiers
Piezoelectric Transducer Amplifiers
Battery-Powered Equipment
Portable Equipment
Sensor Interfaces
Medical Instrumentation
Mobile Communications
Audio Outputs
Smoke Detectors
Mobile Telephones
PCMCIA Cards

PACKAGE/ORDERING INFORMATION

MODEL	PACKAGE DESCRIPTION	SPECIFIED TEMPERATURE RANGE	ORDERING NUMBER	PACKAGE MARKING	PACKING OPTION
SGM8545	SOT-23-5	-40°C to +125°C	SGM8545XN5/TR	8545	Tape and Reel, 3000

Green (RoHS & HSF): SG Micro Corp defines "Green" to mean Pb-Free (RoHS compatible) and free of halogen substances. If you have additional comments or questions, please contact your SGMICRO representative directly.

ABSOLUTE MAXIMUM RATINGS

Supply Voltage, +V_S to -V_S 6V
 Input Common Mode Voltage Range
 (-V_S) - 0.3V to (+V_S) + 0.3V
 Package Thermal Resistance @ T_A = +25°C
 SOT-23-5, θ_{JA} 190°C/W
 Junction Temperature +150°C
 Storage Temperature Range -65°C to +150°C
 Lead Temperature (Soldering, 10s) +260°C
 ESD Susceptibility
 HBM 4000V
 MM 400V

RECOMMENDED OPERATING CONDITIONS

Operating Temperature Range -40°C to +125°C

OVERSTRESS CAUTION

Stresses beyond those listed in Absolute Maximum Ratings may cause permanent damage to the device. Exposure to absolute maximum rating conditions for extended periods may affect reliability. Functional operation of the device at any conditions beyond those indicated in the Recommended Operating Conditions section is not implied.

ESD SENSITIVITY CAUTION

This integrated circuit can be damaged if ESD protections are not considered carefully. SGMICRO recommends that all

integrated circuits be handled with appropriate precautions. Failure to observe proper handling and installation procedures can cause damage. ESD damage can range from subtle performance degradation to complete device failure. Precision integrated circuits may be more susceptible to damage because even small parametric changes could cause the device not to meet the published specifications.

DISCLAIMER

SG Micro Corp reserves the right to make any change in circuit design, or specifications without prior notice.

PIN CONFIGURATION

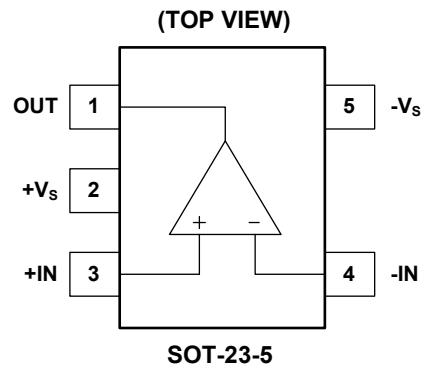

ELECTRICAL CHARACTERISTICS(At $V_S = 5V$, $R_L = 100k\Omega$ connected to $V_S/2$ and $V_{OUT} = V_S/2$, unless otherwise noted.)

PARAMETER	SYMBOL	CONDITIONS	TYP	MIN/MAX OVER TEMPERATURE			
			+25°C	+25°C	-40°C to +125°C	UNITS	MIN/MAX
Input Characteristics							
Input Offset Voltage	V_{OS}	$V_{CM} = V_S/2$	0.8	3.5		mV	MAX
Input Bias Current	I_B		0.5			pA	TYP
Input Offset Current	I_{OS}		0.5			pA	TYP
Input Common Mode Voltage Range	V_{CM}	$V_S = 5.5V$	-0.1 to 5.6			V	TYP
Common Mode Rejection Ratio	CMRR	$V_S = 5.5V, V_{CM} = -0.1V$ to 4V	88	71	70	dB	MIN
		$V_S = 5.5V, V_{CM} = -0.1V$ to 5.6V	76	60	58		
Open-Loop Voltage Gain	A_{OL}	$R_L = 5k\Omega, V_{OUT} = 0.1V$ to 4.9V	100	74	72	dB	MIN
		$R_L = 100k\Omega, V_{OUT} = 0.035V$ to 4.965V	105	85	77		
Input Offset Voltage Drift	$\Delta V_{OS}/\Delta T$		2.7			$\mu V/^\circ C$	TYP
Output Characteristics							
Output Voltage Swing	V_{OH}	$R_L = 100k\Omega$	4.997	4.980	4.970	V	MIN
	V_{OL}	$R_L = 100k\Omega$	5	20	30	mV	MAX
	V_{OH}	$R_L = 10k\Omega$	4.992	4.970	4.960	V	MIN
	V_{OL}	$R_L = 10k\Omega$	8	30	40	mV	MAX
Output Current	I_{SOURCE}	$R_L = 10\Omega$ to $V_S/2$	84	60	45	mA	MIN
	I_{SINK}		75	60	45		
Power Supply							
Operating Voltage Range				2.1	2.5	V	MIN
				5.5	5.5	V	MAX
Power Supply Rejection Ratio	PSRR	$V_S = 2.5V$ to 5.5V, $V_{CM} = 0.5V$	86	70	68	dB	MIN
Quiescent Current	I_Q		48	69	89	μA	MAX
Dynamic Performance ($C_L = 100pF$)							
Gain-Bandwidth Product	GBP		1.1			MHz	TYP
Slew Rate	SR	$G = +1, 2V$ Output Step	0.52			$V/\mu s$	TYP
Settling Time to 0.1%	t_s	$G = +1, 2V$ Output Step	5.3			μs	TYP
Overload Recovery Time		$V_{IN} \cdot G = V_S$	2.6			μs	TYP
Noise Performance							
Input Voltage Noise Density	e_n	$f = 1kHz$	27			nV/\sqrt{Hz}	TYP
		$f = 10kHz$	20			nV/\sqrt{Hz}	TYP

TYPICAL PERFORMANCE CHARACTERISTICS

At $T_A = +25^\circ\text{C}$, $V_S = 5\text{V}$, and $R_L = 100\text{k}\Omega$ connected to $V_S/2$, unless otherwise noted.

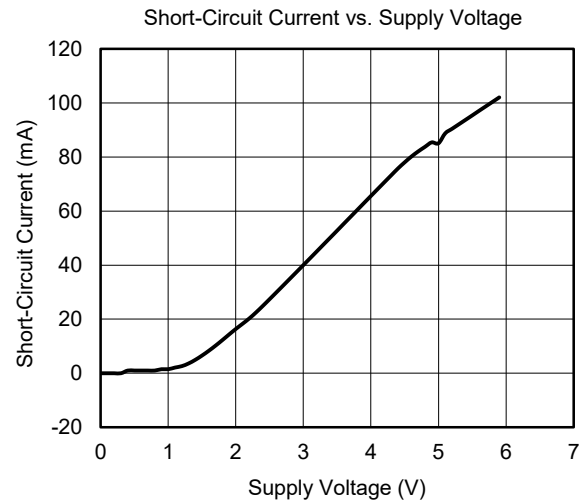
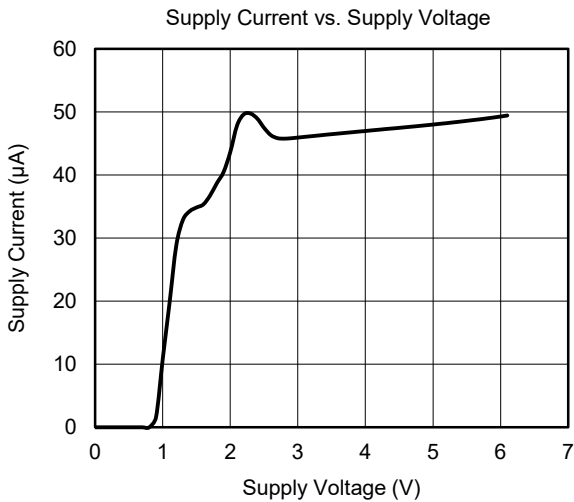
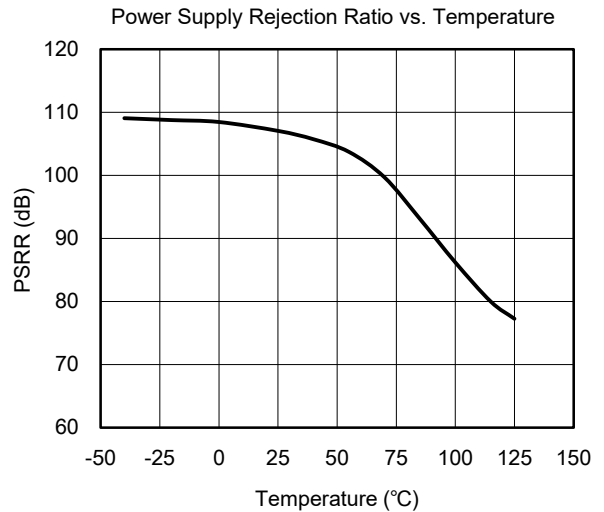
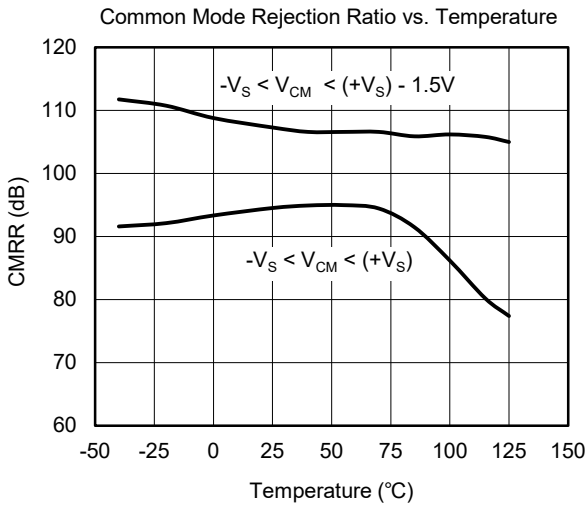
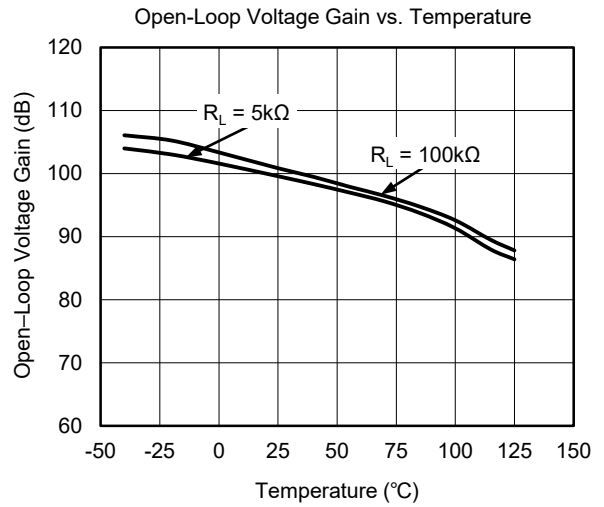
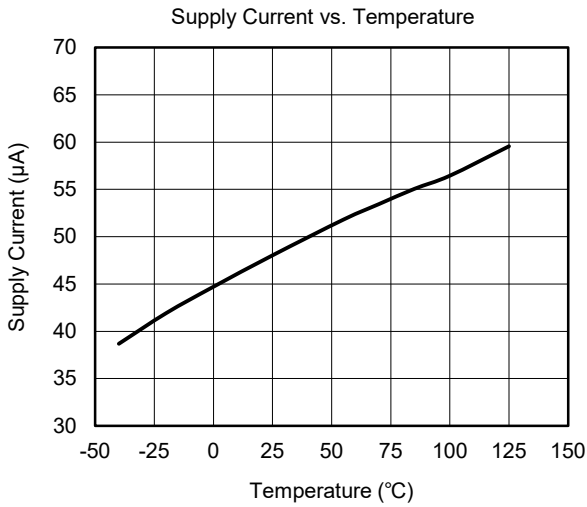

TYPICAL PERFORMANCE CHARACTERISTICS (continued)

At $T_A = +25^\circ\text{C}$, $V_S = 5\text{V}$, and $R_L = 100\text{k}\Omega$ connected to $V_S/2$, unless otherwise noted.

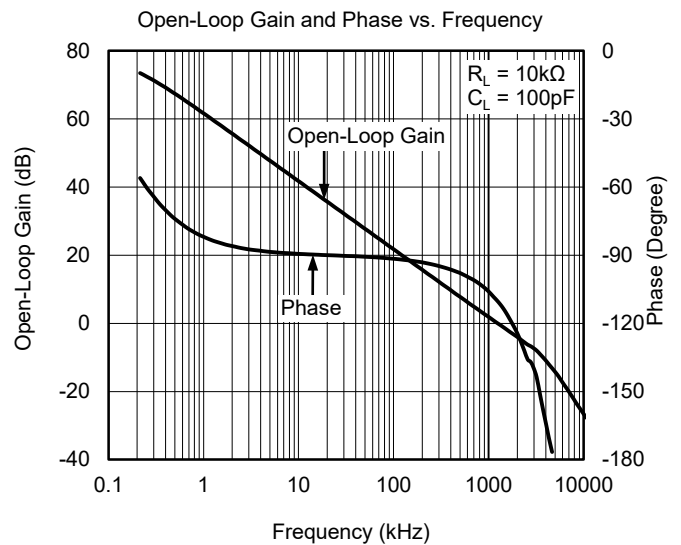
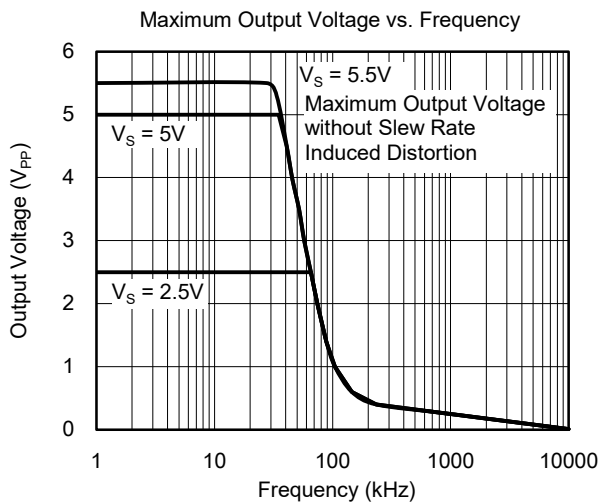
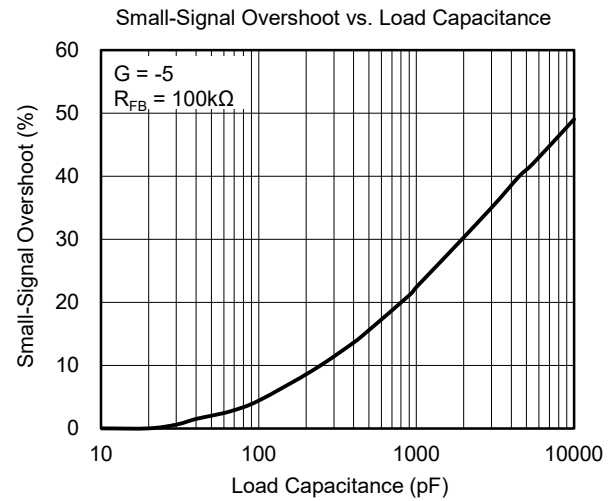
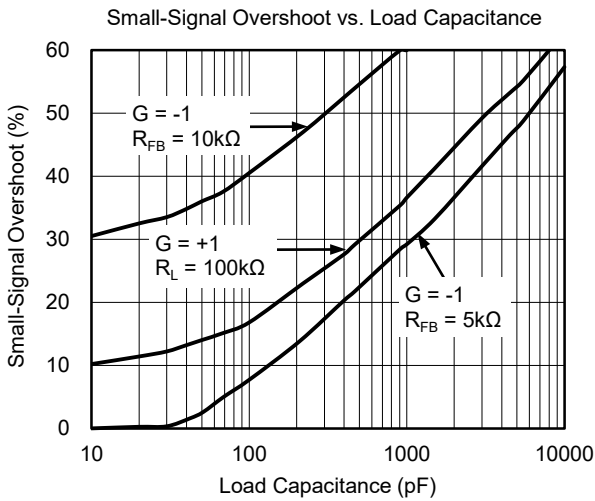
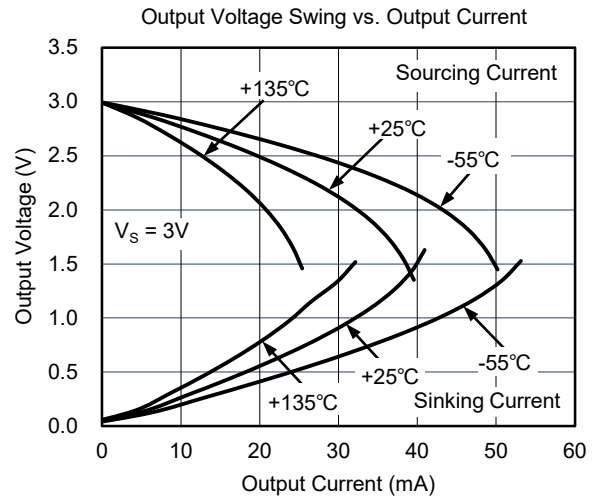
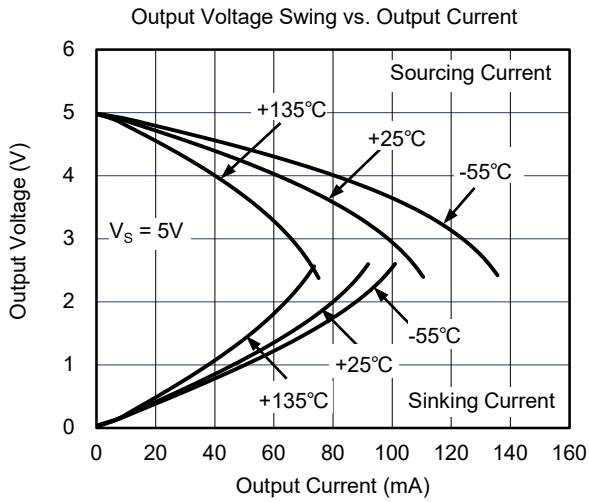

TYPICAL PERFORMANCE CHARACTERISTICS (continued)

At $T_A = +25^\circ\text{C}$, $V_S = 5\text{V}$, and $R_L = 100\text{k}\Omega$ connected to $V_S/2$, unless otherwise noted.

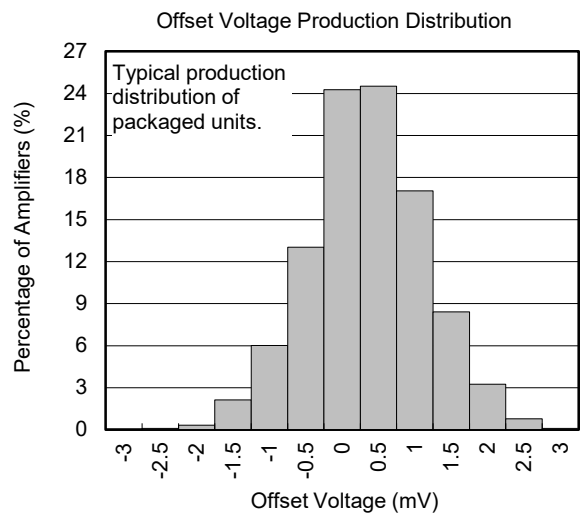
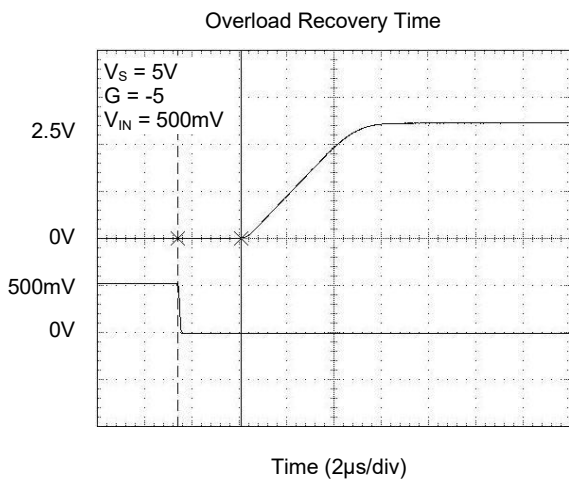
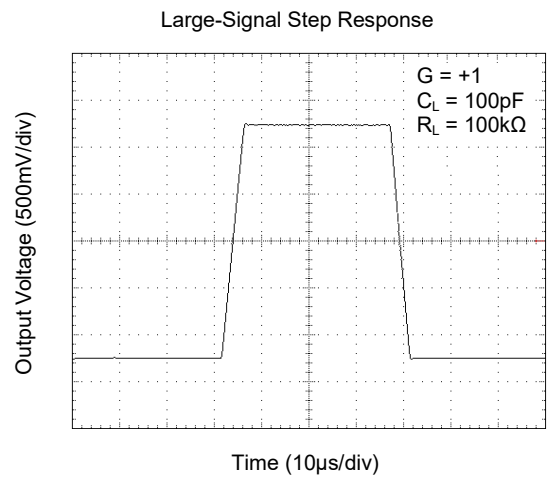
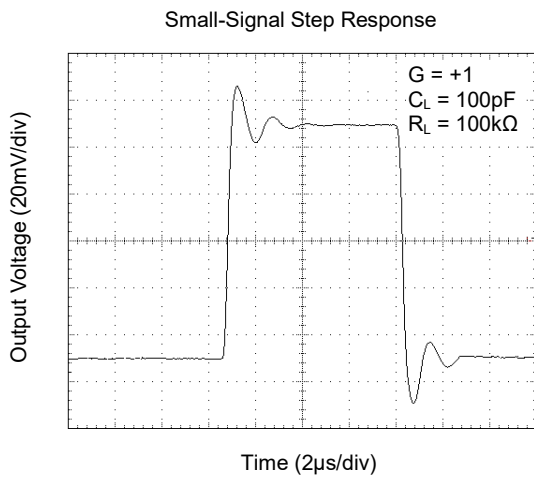
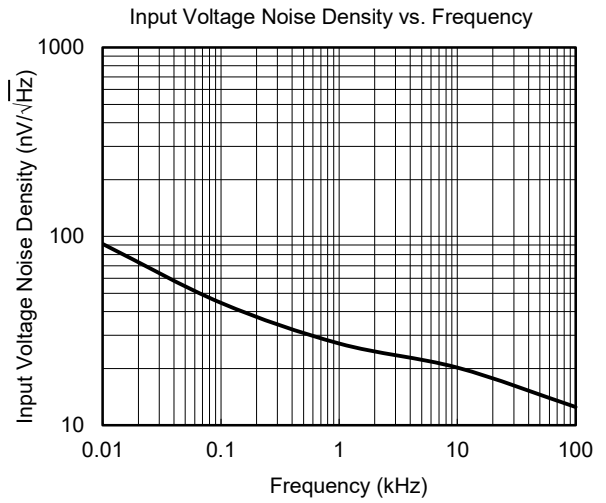
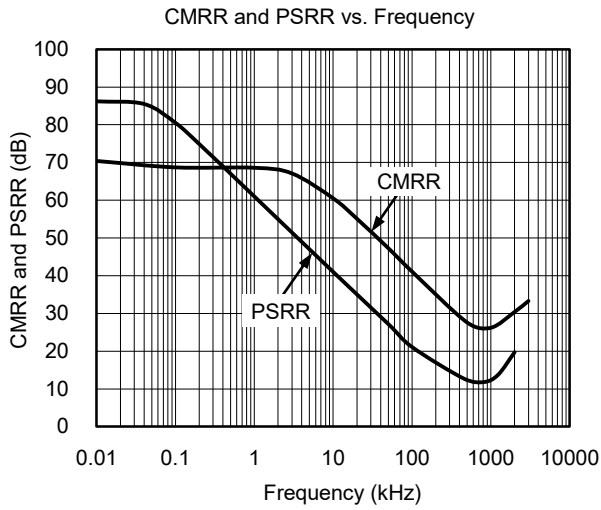

APPLICATION INFORMATION

Rail-to-Rail Input

When SGM8545 works at the power supply between 2.1V and 5.5V, the input common mode voltage range is from $(-V_S) - 0.1V$ to $(+V_S) + 0.1V$. In Figure 1, the ESD diodes between the inputs and the power supply rails will clamp the input voltage not to exceed the rails.

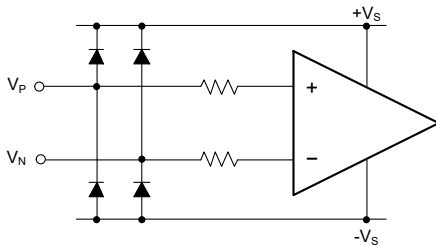

Figure 1. Input Equivalent Circuit

Rail-to-Rail Output

The SGM8545 supports rail-to-rail output operation. In single power supply application, for example, when $+V_S = 5V$, $-V_S = GND$, 100kΩ load resistor is tied from OUT pin to $V_S/2$, the typical output swing range is from 0.005V to 4.997V.

Driving Capacitive Loads

The SGM8545 is designed for unity-gain stable for capacitive load up to 250pF. If greater capacitive load must be driven in application, the circuit in Figure 2 can be used. In this circuit, the IR drop voltage generated by R_{ISO} is compensated by feedback loop.

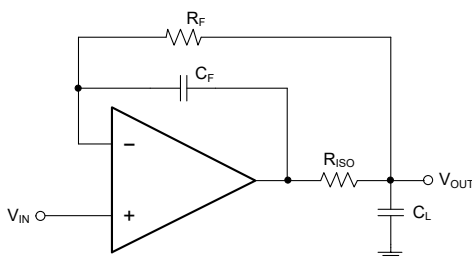

Figure 2. Circuit to Drive Heavy Capacitive Load

Power Supply Decoupling and Layout

A clean and low noise power supply is very important in amplifier circuit design, besides of input signal noise, the power supply is one of important source of noise to the amplifier through $+V_S$ and $-V_S$ pins. Power supply bypassing is an effective method to clear up the noise at power supply, and the low impedance path to ground of decoupling capacitor will bypass the noise to GND. In application, 10µF ceramic capacitor paralleled with 0.1µF or 0.01µF ceramic capacitor is used in Figure 3. The ceramic capacitors should be placed as close as possible to $+V_S$ and $-V_S$ power supply pins.

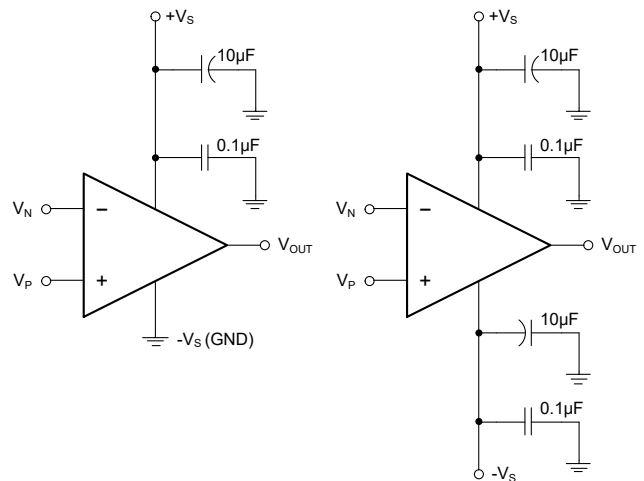

Figure 3. Amplifier Power Supply Bypassing

APPLICATION INFORMATION (continued)

Typical Application Circuits

Difference Amplifier

The circuit in Figure 4 is a design example of classical difference amplifier. If $R_4/R_3 = R_2/R_1$, then $V_{OUT} = (V_P - V_N) \times R_2/R_1 + V_{REF}$.

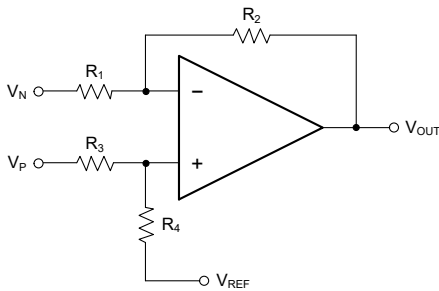

Figure 4. Difference Amplifier

High Input Impedance Difference Amplifier

The circuit in Figure 5 is a design example of high input impedance difference amplifier, the added amplifiers at the input are used to increase the input impedance and eliminate drawback of low input impedance in Figure 4.

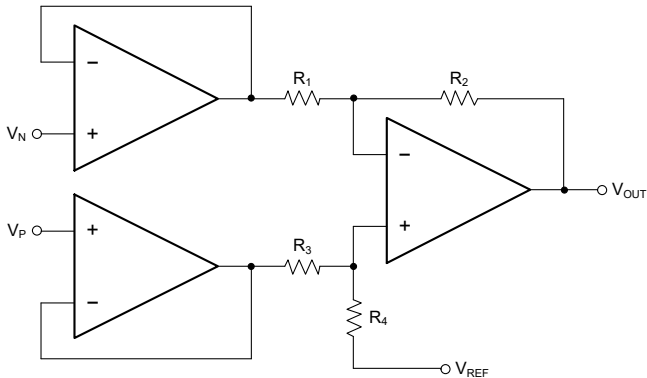

Figure 5. High Input Impedance Difference Amplifier

Active Low-Pass Filter

The circuit in Figure 6 is a design example of active low-pass filter, the DC gain is equal to $-R_2/R_1$ and the -3dB corner frequency is equal to $1/2\pi R_2 C$. In this design, the filter bandwidth must be less than the bandwidth of the amplifier, the resistor values must be selected as low as possible to reduce ringing or oscillation generated by the parasitic parameters in PCB layout.

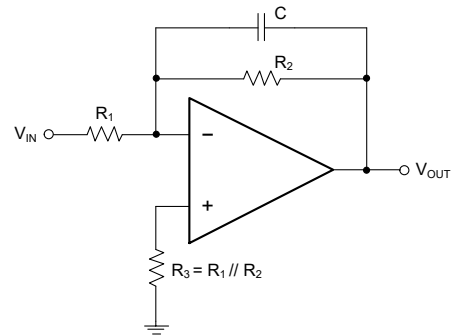

Figure 6. Active Low-Pass Filter

REVISION HISTORY

NOTE: Page numbers for previous revisions may differ from page numbers in the current version.

	Page
NOVEMBER 2018 – REV.B.3 to REV.B.4	
Added Open-Loop Gain and Phase vs. Frequency	5
JANUARY 2013 – REV.B.2 to REV.B.3	
Added Tape and Reel Information	10, 11
DECEMBER 2011 – REV.B.1 to REV.B.2	
New version.....	All
JULY 2010 – REV.B to REV.B.1	
Changed Electrical Characteristics section	3
Changed Power Supply Rejection Ratio vs. Temperature	6
NOVEMBER 2006 – REV.A to REV.B	
Changed Absolute Maximum Ratings	3
Changes from Original (SEPTEMBER 2005) to REV.A	
Changed from product preview to production data.....	All

PACKAGE OUTLINE DIMENSIONS

SOT-23-5

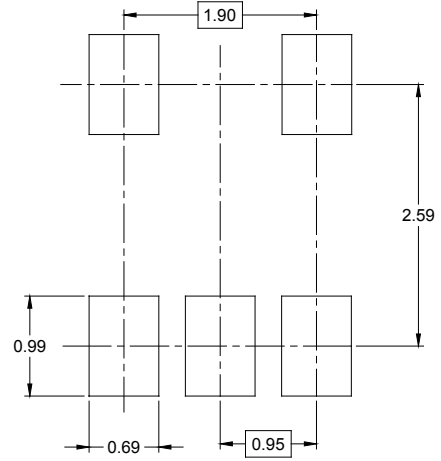

RECOMMENDED LAND PATTERN (Unit: mm)



Symbol	Dimensions In Millimeters		Dimensions In Inches	
	MIN	MAX	MIN	MAX
A	1.050	1.250	0.041	0.049
A1	0.000	0.100	0.000	0.004
A2	1.050	1.150	0.041	0.045
b	0.300	0.500	0.012	0.020
c	0.100	0.200	0.004	0.008
D	2.820	3.020	0.111	0.119
E	1.500	1.700	0.059	0.067
E1	2.650	2.950	0.104	0.116
e	0.950 BSC		0.037 BSC	
e1	1.900 BSC		0.075 BSC	
L	0.300	0.600	0.012	0.024
θ	0°	8°	0°	8°

TAPE AND REEL INFORMATION

REEL DIMENSIONS



TAPE DIMENSIONS



NOTE: The picture is only for reference. Please make the object as the standard.

KEY PARAMETER LIST OF TAPE AND REEL

Package Type	Reel Diameter	Reel Width W1 (mm)	A0 (mm)	B0 (mm)	K0 (mm)	P0 (mm)	P1 (mm)	P2 (mm)	W (mm)	Pin1 Quadrant
SOT-23-5	7"	9.5	3.20	3.20	1.40	4.0	4.0	2.0	8.0	Q3

DD0001

PACKAGE INFORMATION

CARTON BOX DIMENSIONS



NOTE: The picture is only for reference. Please make the object as the standard.

KEY PARAMETER LIST OF CARTON BOX

Reel Type	Length (mm)	Width (mm)	Height (mm)	Pizza/Carton
7" (Option)	368	227	224	8
7"	442	410	224	18

DD0002