



SGM4832

1.1MHz, 46 μ A, Rail-to-Rail I/O CMOS Operational Amplifier

GENERAL DESCRIPTION

The SGM4832 is a dual, voltage feedback amplifier. The device can operate from 2.1V to 5.5V single supply, while consuming only 46 μ A quiescent current per amplifier. It provides rail-to-rail input with a wide input common mode voltage range and rail-to-rail output voltage swing. This feature makes SGM4832 appropriate for buffering ASIC.

The SGM4832 offers a gain-bandwidth product of 1.1MHz and an ultra-low input bias current of 0.5pA. It is well suited for piezoelectric sensors, integrators and photodiode amplifiers.

The SGM4832 is designed into a wide range of applications, such as battery-powered instrumentation, safety monitoring, portable systems, and transducer interface circuits in low power systems.

The SGM4832 is available in a Green TDFN-2 \times 2-8L package. It is specified over the extended -40 $^{\circ}$ C to +125 $^{\circ}$ C temperature range.

FEATURES

- **Input Offset Voltage: 3.5mV (MAX)**
- **Ultra-Low Input Bias Current: 0.5pA**
- **Unity-Gain Stable**
- **Gain-Bandwidth Product: 1.1MHz**
- **Rail-to-Rail Input and Output**
- **Supply Voltage Range: 2.1V to 5.5V**
- **Input Voltage Range:**
 - 0.1V to +5.6V with $V_S = 5.5V$
- **Low Supply Current: 46 μ A/Amplifier**
- **-40 $^{\circ}$ C to +125 $^{\circ}$ C Operating Temperature Range**
- **Available in a Green TDFN-2 \times 2-8L Package**

APPLICATIONS

ASIC Input or Output Amplifiers
Piezoelectric Transducer Amplifiers
Battery-Powered Equipment
Portable Equipment
Sensor Interfaces
Medical Instrumentation
Mobile Communications
Audio Outputs
Smoke Detectors
Mobile Telephones
Notebook PCs
PCMCIA Cards

PACKAGE/ORDERING INFORMATION

MODEL	PACKAGE DESCRIPTION	SPECIFIED TEMPERATURE RANGE	ORDERING NUMBER	PACKAGE MARKING	PACKING OPTION
SGM4832	TDFN-2×2-8L	-40°C to +125°C	SGM4832XTDE8G/TR	4832 XXXX	Tape and Reel, 3000

MARKING INFORMATION

NOTE: XXXX = Date Code.

XXXX

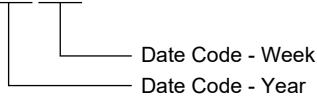

Green (RoHS & HSF): SG Micro Corp defines "Green" to mean Pb-Free (RoHS compatible) and free of halogen substances. If you have additional comments or questions, please contact your SGMICRO representative directly.

ABSOLUTE MAXIMUM RATINGS

Supply Voltage, +V_s to -V_s6V
 Common Mode Input Voltage (-V_s) - 0.3V to (+V_s) + 0.3V
 Junction Temperature+150°C
 Storage Temperature Range -65°C to +150°C
 Lead Temperature (Soldering, 10s)+260°C
 ESD Susceptibility
 HBM 4000V
 MM 400V

RECOMMENDED OPERATING CONDITIONS

Operating Temperature Range-40°C to +125°C

OVERSTRESS CAUTION

Stresses beyond those listed in Absolute Maximum Ratings may cause permanent damage to the device. Exposure to absolute maximum rating conditions for extended periods may affect reliability. Functional operation of the device at any conditions beyond those indicated in the Recommended Operating Conditions section is not implied.

ESD SENSITIVITY CAUTION

This integrated circuit can be damaged if ESD protections are not considered carefully. SGMICRO recommends that all integrated circuits be handled with appropriate precautions. Failure to observe proper handling and installation procedures can cause damage. ESD damage can range from subtle

performance degradation to complete device failure. Precision integrated circuits may be more susceptible to damage because even small parametric changes could cause the device not to meet the published specifications.

DISCLAIMER

SG Micro Corp reserves the right to make any change in circuit design, or specifications without prior notice.

PIN CONFIGURATION

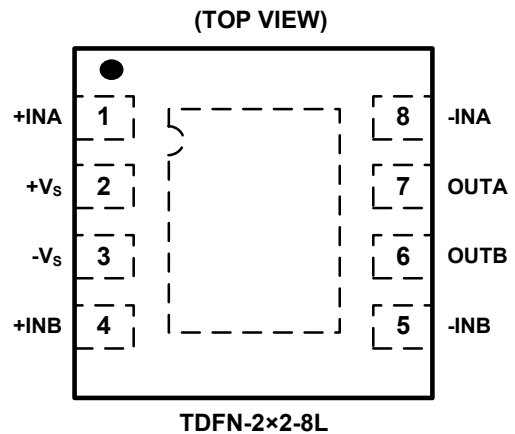

ELECTRICAL CHARACTERISTICS(At $V_S = 5V$, $R_L = 100k\Omega$ connected to $V_S/2$ and $V_{OUT} = V_S/2$, unless otherwise noted.)

PARAMETER	SYMBOL	CONDITIONS	SGM4832					
			TYP	MIN/MAX OVER TEMPERATURE			UNITS	MIN/MAX
			+25°C	+25°C	-40°C to +125°C			
Input Characteristics								
Input Offset Voltage	V_{OS}	$V_{CM} = V_S/2$	0.8	3.5		mV	MAX	
Input Bias Current	I_B		0.5			pA	TYP	
Input Offset Current	I_{OS}		0.5			pA	TYP	
Input Common Mode Voltage Range	V_{CM}	$V_S = 5.5V$	-0.1 to +5.6			V	TYP	
Common Mode Rejection Ratio	CMRR	$V_S = 5.5V, V_{CM} = -0.1V$ to +4V	87	71	69	dB	MIN	
		$V_S = 5.5V, V_{CM} = -0.1V$ to +5.6V	80	60	56			
Open-Loop Voltage Gain	A_{OL}	$R_L = 5k\Omega, V_{OUT} = +0.1V$ to +4.9V	98	80	73	dB	MIN	
		$R_L = 100k\Omega, V_{OUT} = +0.035V$ to +4.965V	105	85	74			
Input Offset Voltage Drift	$\Delta V_{OS}/\Delta T$		2.7			$\mu V/^\circ C$	TYP	
Output Characteristics								
Output Voltage Swing from Rail	V_{OH}	$R_L = 100k\Omega$	4.997	4.980	4.970	V	MIN	
	V_{OL}	$R_L = 100k\Omega$	5	20	30	mV	MAX	
	V_{OH}	$R_L = 10k\Omega$	4.992	4.970	4.960	V	MIN	
	V_{OL}	$R_L = 10k\Omega$	8	30	40	mV	MAX	
Output Current	I_{SOURCE}	$R_L = 10\Omega$ to $V_S/2$	85	60	45	mA	MIN	
	I_{SINK}		75	60	45			
Power Supply								
Operating Voltage Range				2.1	2.5	V	MIN	
				5.5	5.5	V	MAX	
Power Supply Rejection Ratio	PSRR	$V_S = 2.5V$ to $5.5V, V_{CM} = +0.5V$	87	70	64	dB	MIN	
Quiescent Current/Amplifier	I_Q		46	69	89	μA	MAX	
Dynamic Performance ($C_L = 100pF$)								
Gain-Bandwidth Product	GBP		1.1			MHz	TYP	
Slew Rate	SR	$G = +1, 2V$ output step	0.52			$V/\mu s$	TYP	
Settling Time to 0.1%	t_s	$G = +1, 2V$ output step	5.3			μs	TYP	
Overload Recovery Time		$V_{IN} \cdot G = V_S$	2.6			μs	TYP	
Noise Performance								
Voltage Noise Density	e_n	$f = 1kHz$	27			nV/\sqrt{Hz}	TYP	
		$f = 10kHz$	20			nV/\sqrt{Hz}	TYP	

TYPICAL PERFORMANCE CHARACTERISTICS

At $T_A = +25^\circ\text{C}$, $V_S = 5\text{V}$, and $R_L = 100\text{k}\Omega$ connected to $V_S/2$, unless otherwise noted.

Small-Signal Step Response

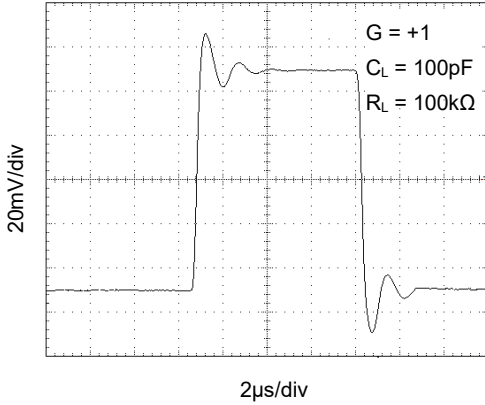

Large-Signal Step Response

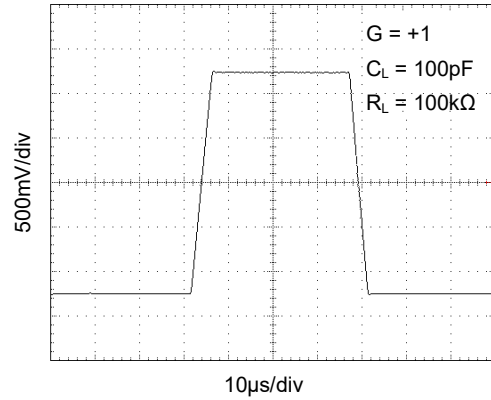

Small-Signal Overshoot vs. Load Capacitance

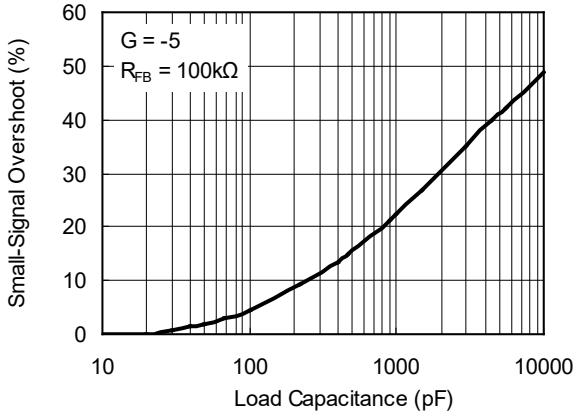

Small-Signal Overshoot vs. Load Capacitance

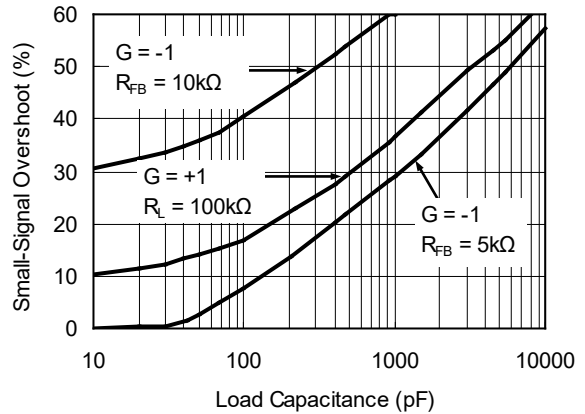

Maximum Output Voltage vs. Frequency

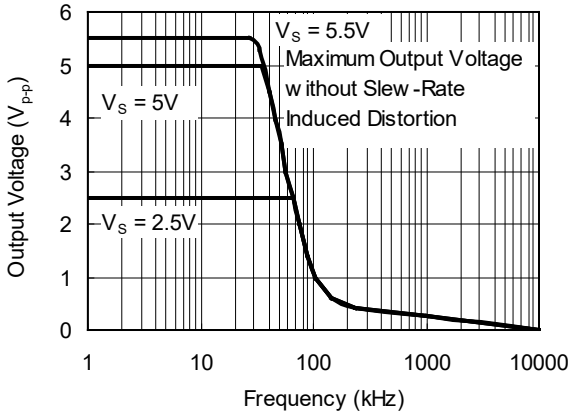

Short-Circuit Current vs. Supply Voltage

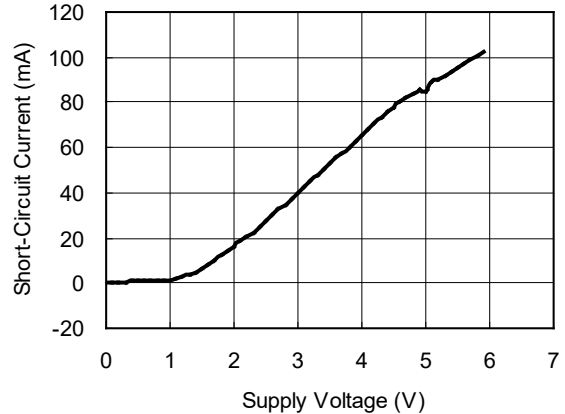

TYPICAL PERFORMANCE CHARACTERISTICS (continued)

At $T_A = +25^\circ\text{C}$, $V_S = 5\text{V}$, and $R_L = 100\text{k}\Omega$ connected to $V_S/2$, unless otherwise noted.

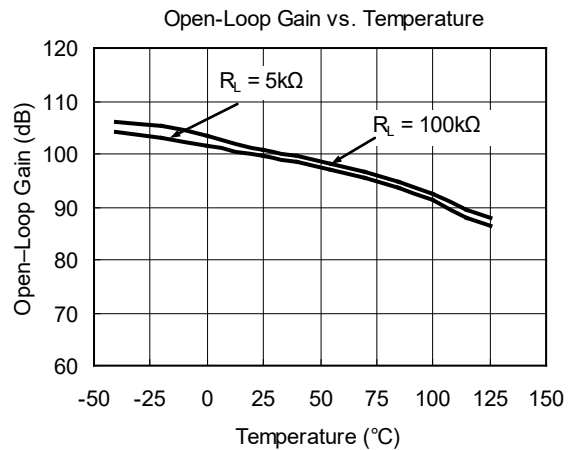
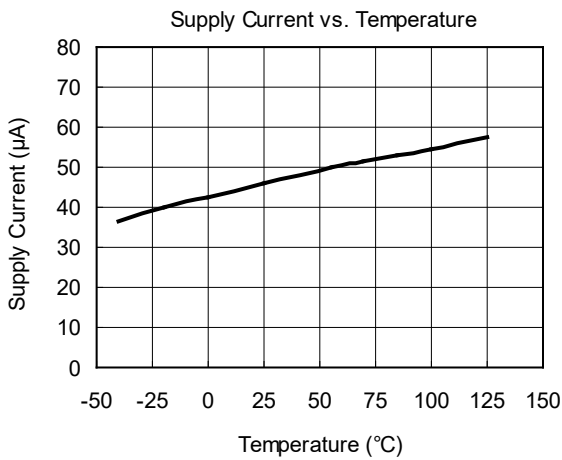
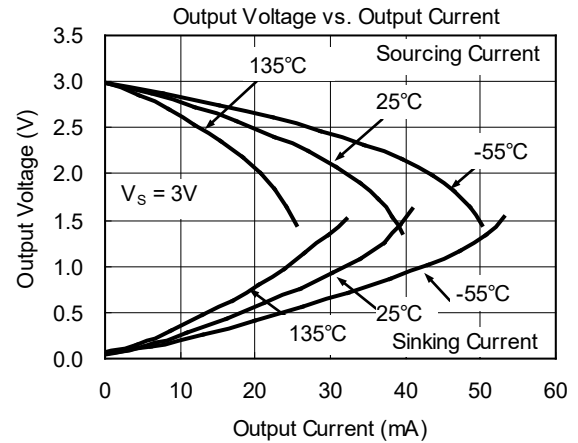
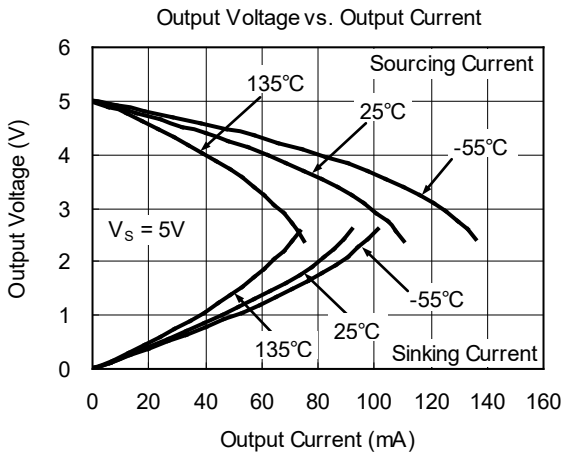
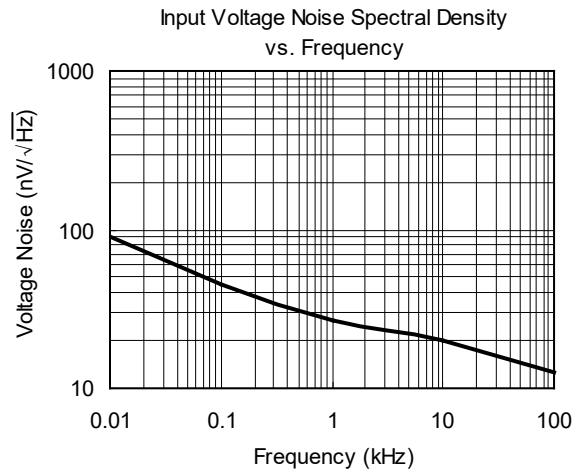
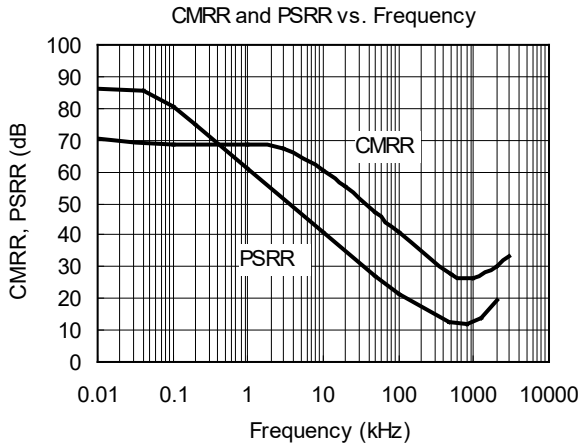

TYPICAL PERFORMANCE CHARACTERISTICS (continued)

At $T_A = +25^\circ\text{C}$, $V_S = 5\text{V}$, and $R_L = 100\text{k}\Omega$ connected to $V_S/2$, unless otherwise noted.

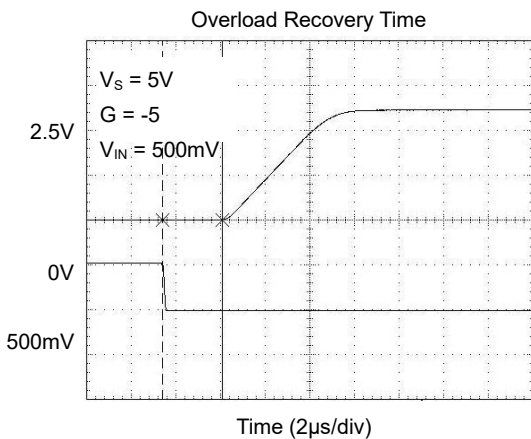
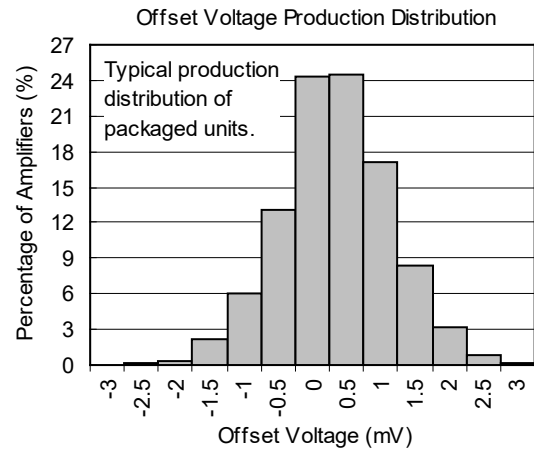
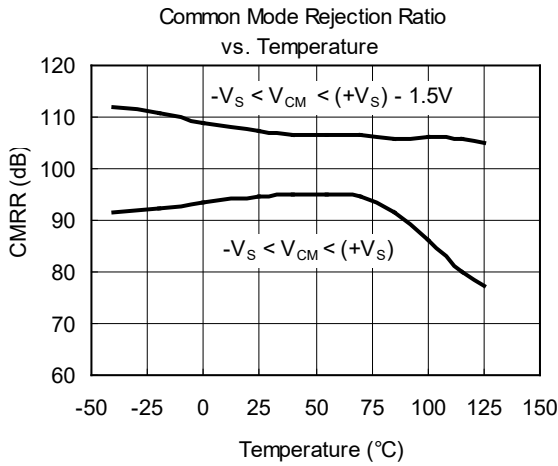
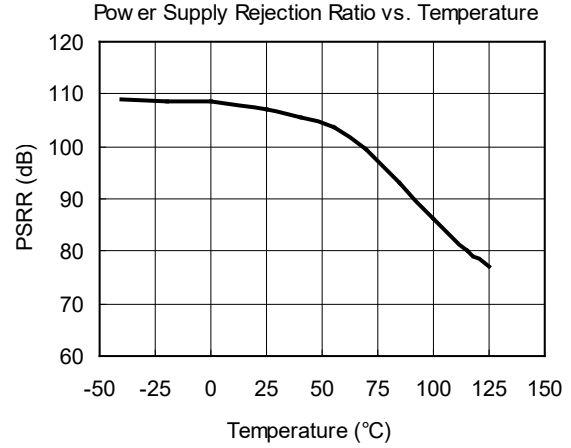
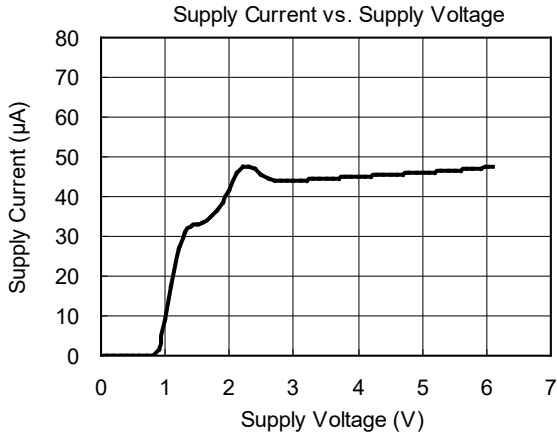

APPLICATION INFORMATION

Rail-to-Rail Input

When SGM4832 works at the power supply between 2.1V and 5.5V, the input common mode voltage range is from $(-V_S) - 0.1V$ to $(+V_S) + 0.1V$. In Figure 1, the ESD diodes between the inputs and the power supply rails will clamp the input voltage not to exceed the rails.

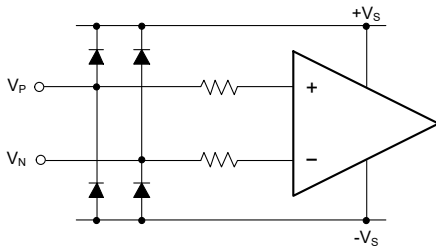

Figure 1. Input Equivalent Circuit

Rail-to-Rail Output

The SGM4832 supports rail-to-rail output operation. In single power supply application, for example, when $+V_S = 5V$, $-V_S = GND$, 100kΩ load resistor is tied from OUT pin to $V_S/2$, the typical output swing range is from 0.005V to 4.997V.

Driving Capacitive Loads

The SGM4832 is designed for unity-gain stable for capacitive load up to 250pF. If greater capacitive load must be driven in application, the circuit in Figure 2 can be used. In this circuit, the IR drop voltage generated by R_{ISO} is compensated by feedback loop.

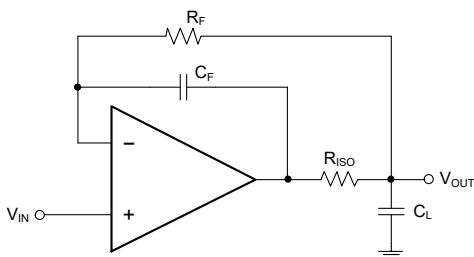

Figure 2. Circuit to Drive Heavy Capacitive Load

Power Supply Decoupling and Layout

A clean and low noise power supply is very important in amplifier circuit design, besides of input signal noise, the power supply is one of important source of noise to the amplifiers through $+V_S$ and $-V_S$ pins. Power supply bypassing is an effective method to clear up the noise at power supply, and the low impedance path to ground of decoupling capacitor will bypass the noise to GND. In application, 10µF ceramic capacitor paralleled with 0.1µF or 0.01µF ceramic capacitor is used in Figure 3. The ceramic capacitors should be placed as close as possible to $+V_S$ and $-V_S$ power supply pins.

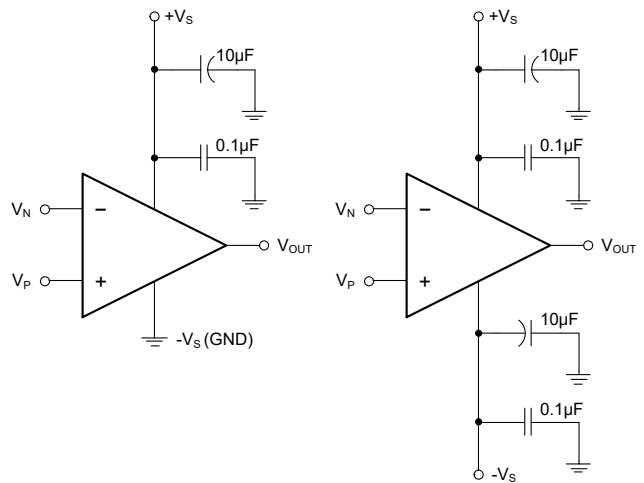

Figure 3. Amplifier Power Supply Bypassing

APPLICATION INFORMATION (continued)

Typical Application Circuits

Difference Amplifier

The circuit in Figure 4 is a design example of classical difference amplifier. If $R_4/R_3 = R_2/R_1$, then $V_{OUT} = (V_P - V_N) \times R_2/R_1 + V_{REF}$.

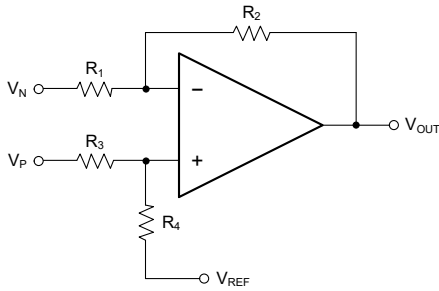

Figure 4. Difference Amplifier

High Input Impedance Difference Amplifier

The circuit in Figure 5 is a design example of high input impedance difference amplifier, the added amplifiers at the input are used to increase the input impedance and eliminate drawback of low input impedance in Figure 4.

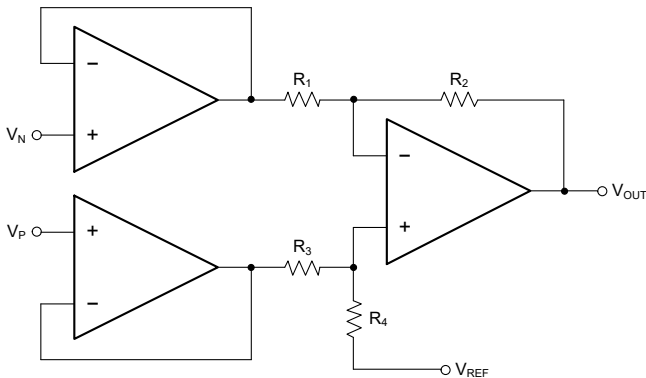

Figure 5. High Input Impedance Difference Amplifier

Active Low-Pass Filter

The circuit in Figure 6 is a design example of active low-pass filter, the DC gain is equal to $-R_2/R_1$ and the -3dB corner frequency is equal to $1/2\pi R_2 C$. In this design, the filter bandwidth must be less than the bandwidth of the amplifier, the resistor values must be selected as low as possible to reduce ringing or oscillation generated by the parasitic parameters in PCB layout.

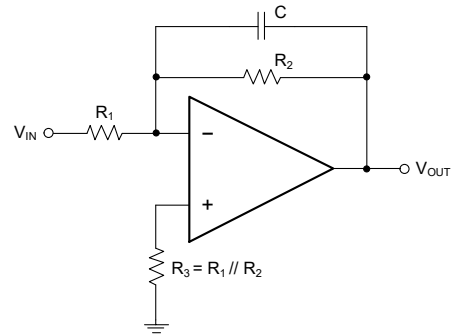

Figure 6. Active Low-Pass Filter

REVISION HISTORY

NOTE: Page numbers for previous revisions may differ from page numbers in the current version.

Changes from Original (FEBRUARY 2017) to REV.A	Page
Changed from product preview to production data.....	All

PACKAGE OUTLINE DIMENSIONS

TDFN-2x2-8L

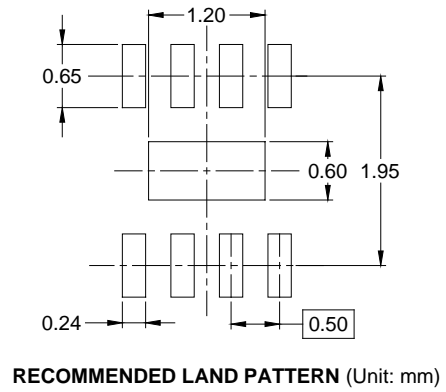
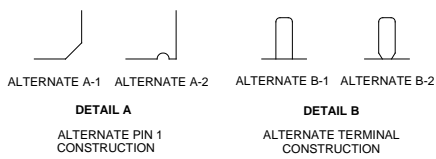
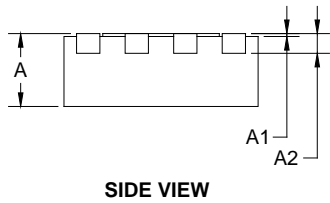
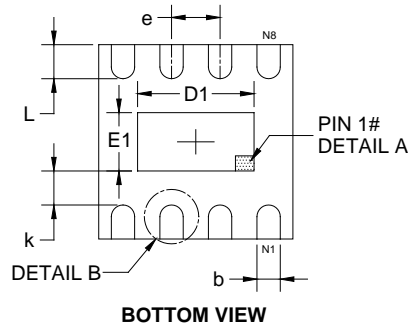
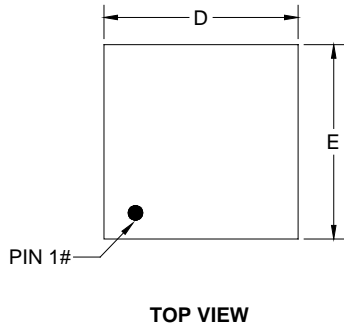

Symbol	Dimensions In Millimeters		
	MIN	MOD	MAX
A	0.700	0.750	0.800
A1	0.000	-	0.050
A2	0.203 REF		
D	1.900	2.000	2.100
E	1.900	2.000	2.100
D1	1.100	1.200	1.300
E1	0.500	0.600	0.700
b	0.180	-	0.300
e	0.500 TYP		
k	0.200 MIN		
L	0.250	0.350	0.450

NOTE: This drawing is subject to change without notice.

PACKAGE INFORMATION

TAPE AND REEL INFORMATION

REEL DIMENSIONS



TAPE DIMENSIONS



NOTE: The picture is only for reference. Please make the object as the standard.

KEY PARAMETER LIST OF TAPE AND REEL

Package Type	Reel Diameter	Reel Width W1 (mm)	A0 (mm)	B0 (mm)	K0 (mm)	P0 (mm)	P1 (mm)	P2 (mm)	W (mm)	Pin1 Quadrant
TDFN-2×2-8L	7"	9.5	2.30	2.30	1.10	4.0	4.0	2.0	8.0	Q1

000001

PACKAGE INFORMATION

CARTON BOX DIMENSIONS



NOTE: The picture is only for reference. Please make the object as the standard.

KEY PARAMETER LIST OF CARTON BOX

Reel Type	Length (mm)	Width (mm)	Height (mm)	Pizza/Carton
7" (Option)	368	227	224	8
7"	442	410	224	18

DD0002