



# SGM8044

## 670nA, Quad Rail-to-Rail I/O Operational Amplifier

---

### GENERAL DESCRIPTION

The SGM8044 is a quad, high precision operational amplifier which can operate from 1.4V to 5.5V single supply, while consuming only 670nA/amplifier quiescent current. It provides rail-to-rail input and output operation. Therefore, the SGM8044 is suitable for use in portable instrumentation and battery-powered systems.

The SGM8044 is unity-gain stable, and features a 15kHz gain-bandwidth product. It is designed to provide optimal performance in low frequency systems, when monitoring battery current and conditioning sensor signal.

The SGM8044 is available in Green SOIC-14, TSSOP-14 and TQFN-3×3-16L packages. It is specified over the extended -40°C to +85°C temperature range.

### FEATURES

- **Low Quiescent Current: 670nA/Amplifier (TYP)**
- **Rail-to-Rail Input and Output**
- **Gain-Bandwidth Product: 15kHz at  $V_S = 5V$  (TYP)**
- **Wide Supply Voltage Range: 1.4V to 5.5V**
- **Unity-Gain Stable**
- **-40°C to +85°C Operating Temperature Range**
- **Available in Green SOIC-14, TSSOP-14 and TQFN-3×3-16L Packages**

### APPLICATIONS

Temperature Measurements  
Toll Booth Tags  
Battery-Powered Systems  
Wearable Products

**PACKAGE/ORDERING INFORMATION**

MODEL	PACKAGE DESCRIPTION	SPECIFIED TEMPERATURE RANGE	ORDERING NUMBER	PACKAGE MARKING	PACKING OPTION
SGM8044	SOIC-14	-40°C to +85°C	SGM8044YS14G/TR	SGM8044YS14 XXXXX	Tape and Reel, 2500
	TSSOP-14	-40°C to +85°C	SGM8044YTS14G/TR	SGM8044 YTS14 XXXXX	Tape and Reel, 3000
	TQFN-3x3-16L	-40°C to +85°C	SGM8044YTQ16G/TR	8044TQ XXXXX	Tape and Reel, 4000

**MARKING INFORMATION**

NOTE: XXXXX = Date Code and Vendor Code.

**XXXXX**

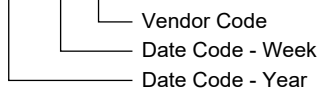

Green (RoHS & HSF): SG Micro Corp defines "Green" to mean Pb-Free (RoHS compatible) and free of halogen substances. If you have additional comments or questions, please contact your SGMICRO representative directly.

**ABSOLUTE MAXIMUM RATINGS**

Supply Voltage.....	6V
Analog Inputs (+IN, -IN).....	(-V <sub>S</sub> ) - 0.1V to (+V <sub>S</sub> ) + 0.1V
Differential Input Voltage.....	(-V <sub>S</sub> ) - (+V <sub>S</sub> )
Junction Temperature.....	+150°C
Storage Temperature Range.....	-65°C to +150°C
Lead Temperature (Soldering, 10s).....	+260°C
ESD Susceptibility	
HBM.....	4000V
MM.....	400V

**RECOMMENDED OPERATING CONDITIONS**

Supply Voltage Range.....	1.4V to 5.5V
Operating Temperature Range.....	-40°C to +85°C

**OVERSTRESS CAUTION**

Stresses beyond those listed in Absolute Maximum Ratings may cause permanent damage to the device. Exposure to absolute maximum rating conditions for extended periods may affect reliability. Functional operation of the device at any conditions beyond those indicated in the Recommended Operating Conditions section is not implied.

**ESD SENSITIVITY CAUTION**

This integrated circuit can be damaged if ESD protections are not considered carefully. SGMICRO recommends that all integrated circuits be handled with appropriate precautions. Failure to observe proper handling and installation procedures can cause damage. ESD damage can range from subtle performance degradation to complete device failure. Precision integrated circuits may be more susceptible to damage because even small parametric changes could cause the device not to meet the published specifications.

**DISCLAIMER**

SG Micro Corp reserves the right to make any change in circuit design, or specifications without prior notice.

PIN CONFIGURATIONS

(TOP VIEW)

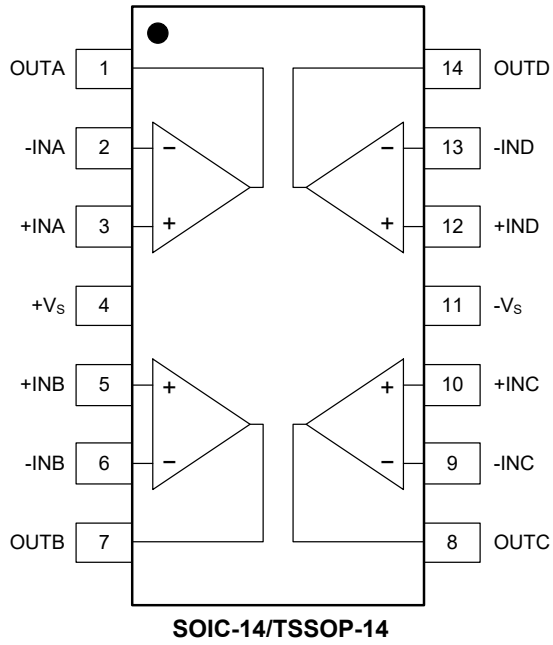

(TOP VIEW)

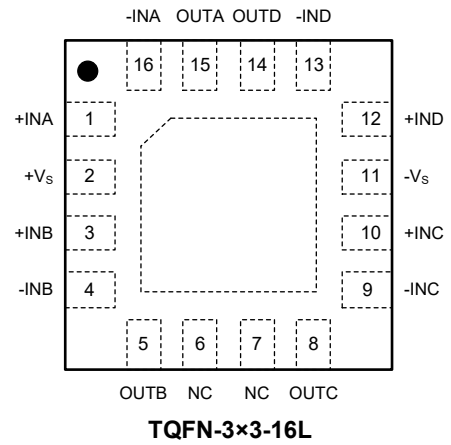

**ELECTRICAL CHARACTERISTICS**(At  $T_A = +25^\circ\text{C}$ ,  $+V_S = 1.4\text{V}$  to  $5\text{V}$ ,  $-V_S = \text{GND}$ ,  $V_{\text{CM}} = +V_S/2$ ,  $V_{\text{OUT}} \approx +V_S/2$  and  $R_L = 1\text{M}\Omega$  to  $+V_S/2$ , unless otherwise noted.)

PARAMETER	SYMBOL	CONDITIONS	MIN	TYP	MAX	UNITS	
<b>DC Electrical Characteristics</b>							
Input Offset Voltage	$V_{\text{OS}}$	$V_{\text{CM}} = +V_S/2$		0.7	2.5	mV	
Input Offset Voltage Drift	$\Delta V_{\text{OS}}/\Delta T$	$V_{\text{CM}} = +V_S/2$ , $-40^\circ\text{C} \leq T_A \leq +85^\circ\text{C}$		2.5		$\mu\text{V}/^\circ\text{C}$	
Power Supply Rejection Ratio	PSRR	$+V_S = 1.4\text{V}$ to $5.5\text{V}$	74	80		dB	
Input Common Mode Voltage Range	$V_{\text{CMR}}$		$(-V_S) - 0.1$		$(+V_S) + 0.1$	V	
Common Mode Rejection Ratio	CMRR	$+V_S = 5.0\text{V}$ , $V_{\text{CM}} = -0.1\text{V}$ to $5.1\text{V}$	65	83		dB	
		$+V_S = 5.0\text{V}$ , $V_{\text{CM}} = 2.5\text{V}$ to $5.1\text{V}$	65	82			
		$+V_S = 5.0\text{V}$ , $V_{\text{CM}} = -0.1\text{V}$ to $2.5\text{V}$	70	80			
Large-Signal Voltage Gain	$A_{\text{VO}}$	$+V_S = 1.4\text{V}$ , $R_L = 50\text{k}\Omega$ , $V_{\text{OUT}} = (+V_S) - 0.1\text{V}$	72	77		dB	
		$+V_S = 2.5\text{V}$ , $R_L = 50\text{k}\Omega$ , $V_{\text{OUT}} = (+V_S) - 0.1\text{V}$		87			
		$+V_S = 5.0\text{V}$ , $R_L = 50\text{k}\Omega$ , $V_{\text{OUT}} = (+V_S) - 0.1\text{V}$	82	93			
Input Bias Current	$I_{\text{B}}$			1		pA	
Input Offset Current	$I_{\text{OS}}$			1		pA	
Maximum Output Voltage Swing	$V_{\text{OH}}$	$+V_S = 1.4\text{V}$ , $R_L = 50\text{k}\Omega$	1.390	1.394		V	
		$+V_S = 2.5\text{V}$ , $R_L = 50\text{k}\Omega$		2.497			
		$+V_S = 5.0\text{V}$ , $R_L = 50\text{k}\Omega$	4.990	4.996			
	$V_{\text{OL}}$	$+V_S = 1.4\text{V}$ , $R_L = 50\text{k}\Omega$			5.4	10	mV
		$+V_S = 2.5\text{V}$ , $R_L = 50\text{k}\Omega$			3.4		
		$+V_S = 5.0\text{V}$ , $R_L = 50\text{k}\Omega$			3.7	10	
Output Short-Circuit Current	$I_{\text{SC}}$	$+V_S = 2.5\text{V}$		5.2		mA	
		$+V_S = 5.0\text{V}$	22	23			
Supply Voltage	$V_{\text{CC}}$		1.4		5.5	V	
Quiescent Current/Amplifier	$I_{\text{Q}}$	$+V_S = 1.4\text{V}$		550		nA	
		$+V_S = 2.5\text{V}$		610			
		$+V_S = 5.0\text{V}$		670	1500		

**ELECTRICAL CHARACTERISTICS (continued)**

(At  $T_A = +25^\circ\text{C}$ ,  $+V_S = 1.4\text{V}$  to  $5\text{V}$ ,  $-V_S = \text{GND}$ ,  $V_{CM} = +V_S/2$ ,  $V_{OUT} \approx +V_S/2$  and  $R_L = 1\text{M}\Omega$  to  $+V_S/2$ ,  $C_L = 60\text{pF}$ , unless otherwise noted.)

PARAMETER	SYMBOL	CONDITIONS	MIN	TYP	MAX	UNITS
<b>AC Electrical Characteristics</b>						
Gain-Bandwidth Product	GBP	$+V_S = 1.4\text{V}$		13.5		kHz
		$+V_S = 2.5\text{V}$		14.5		
		$+V_S = 5.0\text{V}$		15		
Slew Rate	SR	$+V_S = 1.4\text{V}$ , $V_{OUT} = 1\text{V Step}$		3.0		V/ms
		$+V_S = 2.5\text{V}$ , $V_{OUT} = 1\text{V Step}$		3.1		
		$+V_S = 5.0\text{V}$ , $V_{OUT} = 2\text{V Step}$		3.4		
Phase Margin	PM	$+V_S = 1.4\text{V}$ to $5.5\text{V}$		60		$^\circ$
Input Voltage Noise	$e_{n,P-P}$	$+V_S = 1.4\text{V}$ , $f = 0.1\text{Hz}$ to $10\text{Hz}$		3.5		$\mu\text{V}_{P-P}$
		$+V_S = 2.5\text{V}$ , $f = 0.1\text{Hz}$ to $10\text{Hz}$		3.4		
		$+V_S = 5.0\text{V}$ , $f = 0.1\text{Hz}$ to $10\text{Hz}$		3.2		
Input Voltage Noise Density	$e_n$	$+V_S = 1.4\text{V}$ , $f = 1\text{kHz}$		205		$\text{nV}/\sqrt{\text{Hz}}$
		$+V_S = 2.5\text{V}$ , $f = 1\text{kHz}$		185		
		$+V_S = 5.0\text{V}$ , $f = 1\text{kHz}$		190		

**TYPICAL PERFORMANCE CHARACTERISTICS**

At  $T_A = +25^\circ\text{C}$ ,  $+V_S = 1.4\text{V to } 5\text{V}$ ,  $-V_S = \text{GND}$ ,  $V_{CM} = +V_S/2$ ,  $V_{OUT} \approx +V_S/2$  and  $R_L = 1\text{M}\Omega$  to  $+V_S/2$ ,  $C_L = 60\text{pF}$ , unless otherwise noted.

Large-Signal Inverting Pulse Response

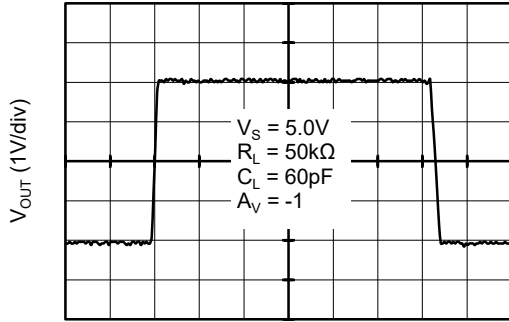

Time (5ms/div)

Large-Signal Non-Inverting Pulse Response

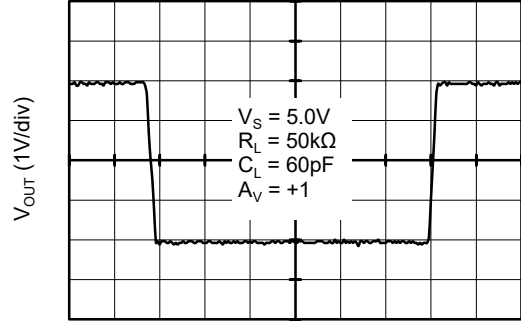

Time (5ms/div)

Small-Signal Inverting Pulse Response

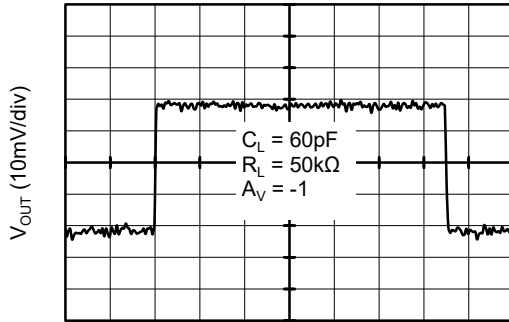

Time (5ms/div)

Small-Signal Non-Inverting Pulse Response

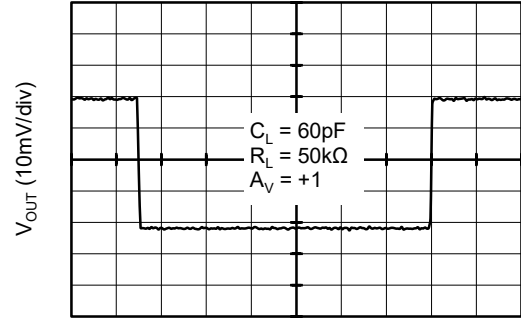

Time (5ms/div)

No Phase Reversal

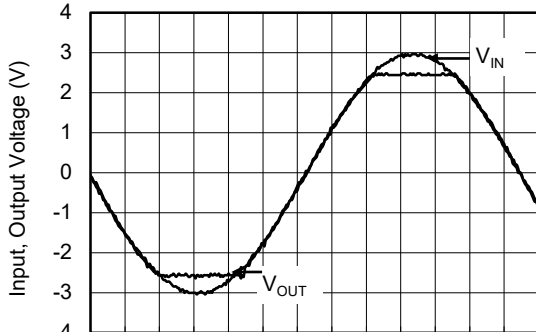

Time (5ms/div)

Slew Rate vs. Temperature

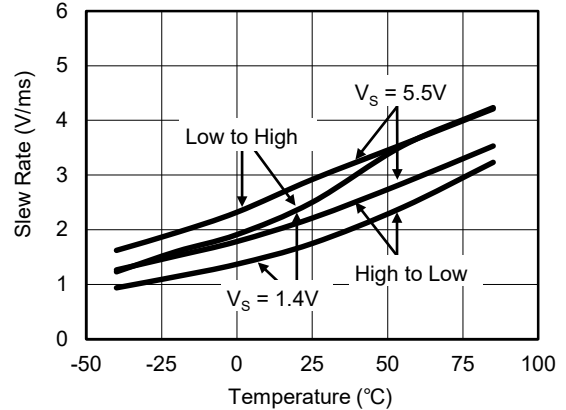

**TYPICAL PERFORMANCE CHARACTERISTICS (continued)**

At  $T_A = +25^\circ\text{C}$ ,  $+V_S = 1.4\text{V to } 5\text{V}$ ,  $-V_S = \text{GND}$ ,  $V_{CM} = +V_S/2$ ,  $V_{OUT} \approx +V_S/2$  and  $R_L = 1\text{M}\Omega$  to  $+V_S/2$ ,  $C_L = 60\text{pF}$ , unless otherwise noted.

Gain-Bandwidth Product and Phase Margin vs. Input Common Mode Voltage

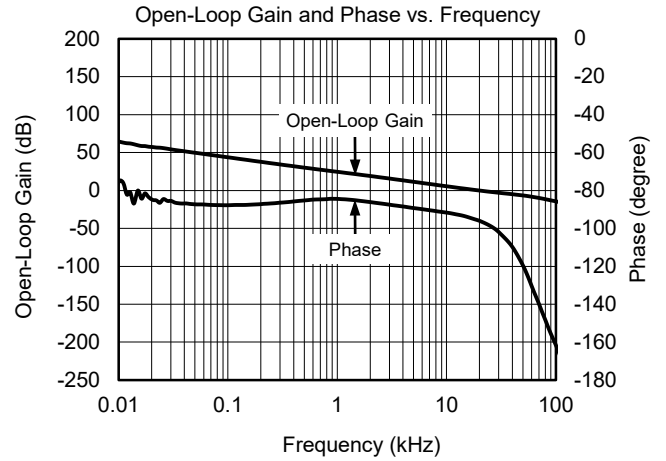
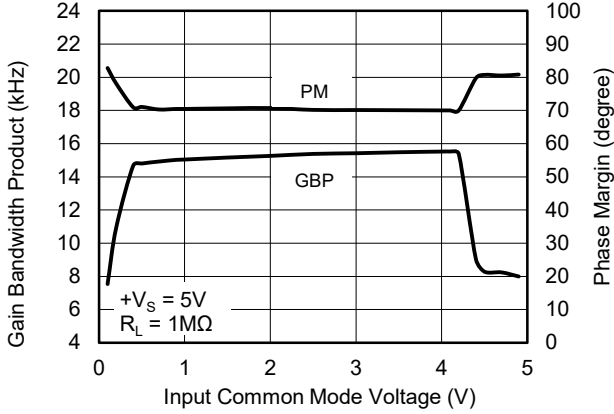

Offset Voltage Production Distribution at +5V

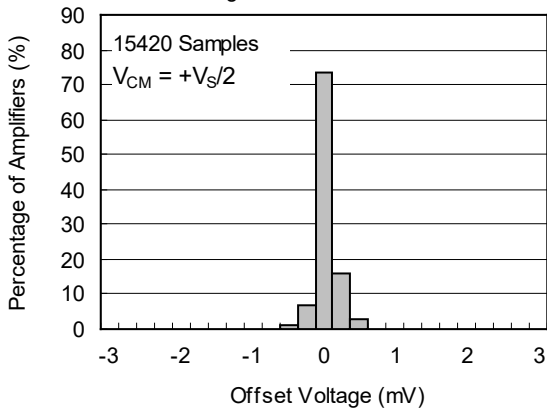

Offset Voltage Production Distribution at +1.4V

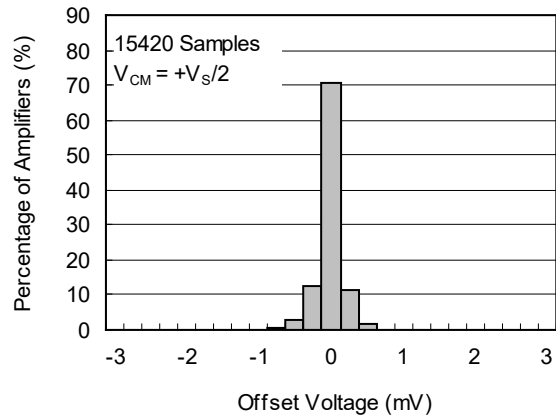

**REVISION HISTORY**

NOTE: Page numbers for previous revisions may differ from page numbers in the current version.

<b>OCTOBER 2017 – REV.A.3 to REV.A.4</b>	<b>Page</b>
Updated Typical Performance Characteristics section .....	6
<b>SEPTEMBER 2015 – REV.A.2 to REV.A.3</b>	<b>Page</b>
Added TQFN-3×3-16L Package .....	All
Updated Package Outline Dimensions section .....	7~8
<b>JANUARY 2013 – REV.A.1 to REV.A.2</b>	<b>Page</b>
Added Tape and Reel Information section .....	9~10
<b>MAY 2011 – REV.A to REV.A.1</b>	<b>Page</b>
Updated Package Description .....	All
<b>Changes from Original (JUNE 2010) to REV.A</b>	<b>Page</b>
Changed from product preview to production data .....	All



PACKAGE OUTLINE DIMENSIONS

SOIC-14

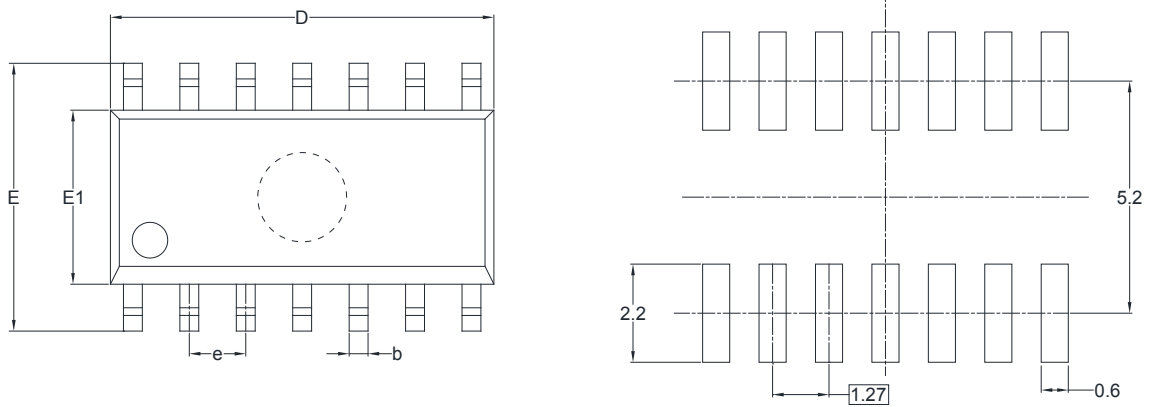

RECOMMENDED LAND PATTERN (Unit: mm)

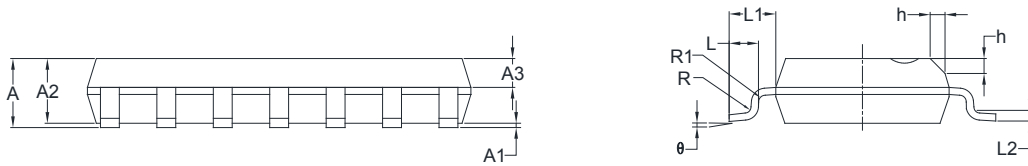

Symbol	Dimensions In Millimeters		Dimensions In Inches	
	MIN	MAX	MIN	MAX
A	1.35	1.75	0.053	0.069
A1	0.10	0.25	0.004	0.010
A2	1.25	1.65	0.049	0.065
A3	0.55	0.75	0.022	0.030
b	0.36	0.49	0.014	0.019
D	8.53	8.73	0.336	0.344
E	5.80	6.20	0.228	0.244
E1	3.80	4.00	0.150	0.157
e	1.27 BSC		0.050 BSC	
L	0.45	0.80	0.018	0.032
L1	1.04 REF		0.040 REF	
L2	0.25 BSC		0.01 BSC	
R	0.07		0.003	
R1	0.07		0.003	
h	0.30	0.50	0.012	0.020
θ	0°	8°	0°	8°

PACKAGE OUTLINE DIMENSIONS

TSSOP-14

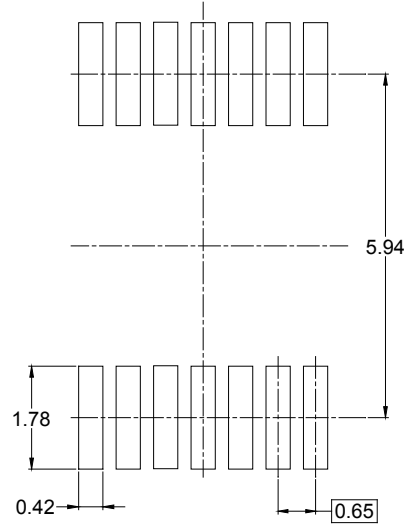
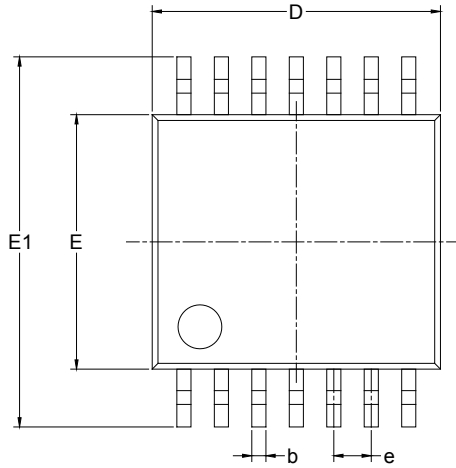

RECOMMENDED LAND PATTERN (Unit: mm)

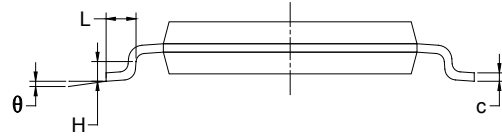
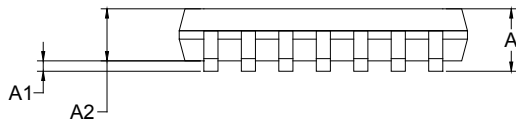

Symbol	Dimensions In Millimeters		Dimensions In Inches	
	MIN	MAX	MIN	MAX
A		1.200		0.047
A1	0.050	0.150	0.002	0.006
A2	0.800	1.050	0.031	0.041
b	0.190	0.300	0.007	0.012
c	0.090	0.200	0.004	0.008
D	4.860	5.100	0.191	0.201
E	4.300	4.500	0.169	0.177
E1	6.250	6.550	0.246	0.258
e	0.650 BSC		0.026 BSC	
L	0.500	0.700	0.02	0.028
H	0.25 TYP		0.01 TYP	
$\theta$	1°	7°	1°	7°

# PACKAGE INFORMATION

## PACKAGE OUTLINE DIMENSIONS

### TQFN-3×3-16L

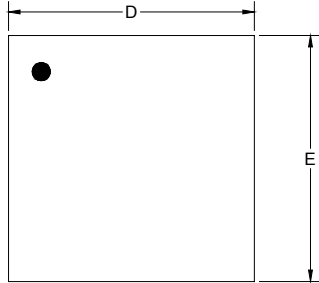

TOP VIEW

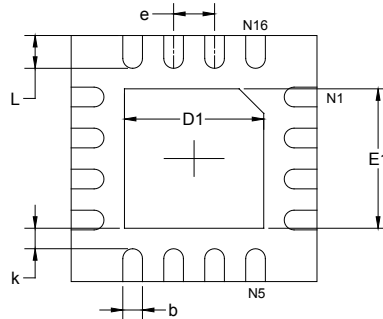

BOTTOM VIEW

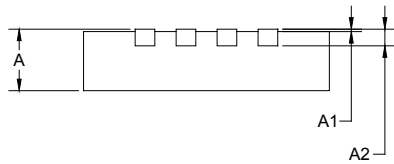

SIDE VIEW

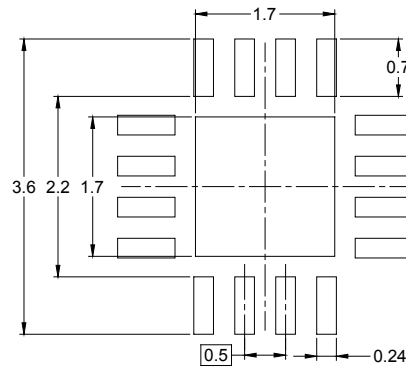

RECOMMENDED LAND PATTERN (Unit: mm)

Symbol	Dimensions In Millimeters		Dimensions In Inches	
	MIN	MAX	MIN	MAX
A	0.700	0.800	0.028	0.031
A1	0.000	0.050	0.000	0.002
A2	0.203 REF		0.008 REF	
D	2.900	3.100	0.114	0.122
D1	1.600	1.800	0.063	0.071
E	2.900	3.100	0.114	0.122
E1	1.600	1.800	0.063	0.071
k	0.200 MIN		0.008 MIN	
b	0.180	0.300	0.007	0.012
e	0.500 TYP		0.020 TYP	
L	0.300	0.500	0.012	0.020

# PACKAGE INFORMATION

## TAPE AND REEL INFORMATION

### REEL DIMENSIONS



### TAPE DIMENSIONS



NOTE: The picture is only for reference. Please make the object as the standard.

### KEY PARAMETER LIST OF TAPE AND REEL

Package Type	Reel Diameter	Reel Width W1 (mm)	A0 (mm)	B0 (mm)	K0 (mm)	P0 (mm)	P1 (mm)	P2 (mm)	W (mm)	Pin1 Quadrant
SOIC-14	13"	16.4	6.60	9.30	2.10	4.0	8.0	2.0	16.0	Q1
TSSOP-14	13"	12.4	6.95	5.60	1.20	4.0	8.0	2.0	12.0	Q1
TQFN-3×3-16L	13"	12.4	3.35	3.35	1.13	4.0	8.0	2.0	12.0	Q1

DD0001

# PACKAGE INFORMATION

## CARTON BOX DIMENSIONS



NOTE: The picture is only for reference. Please make the object as the standard.

## KEY PARAMETER LIST OF CARTON BOX

Reel Type	Length (mm)	Width (mm)	Height (mm)	Pizza/Carton
13"	386	280	370	5

DD0002